



THOMPSON/CENTER
A Smith & Wesson® Company

Safety & Instruction Manual

Omega Muzzleloading Rifle



WARNING: Black Powder or an approved Black Powder substitute such as Pyrodex® are the only propellant powders that are safe to use in a muzzleloading firearm.



Read the instructions and warnings in this manual CAREFULLY BEFORE using this firearm.

SHOCK WAVE® is a Registered Trademark of Alliant Techsystems Inc. and is used under license

THOMPSON/CENTER ARMS
2100 Roosevelt Avenue • Springfield, MA 01104
Toll Free Phone (866) 730-1614
www.tcarms.com

Copyright © 2011 Thompson/Center Arms
All rights reserved.



WARNING



**READ THESE
INSTRUCTIONS AND
WARNINGS CAREFULLY.
BE SURE YOU UNDERSTAND
THESE INSTRUCTIONS AND WARN-
INGS BEFORE USING THIS FIREARM.
FAILURE TO READ THESE INSTRUC-
TIONS AND TO FOLLOW THESE WARN-
INGS MAY RESULT IN SERIOUS INJURY
OR DEATH TO YOU AND OTHERS
AND DAMAGE TO PROPERTY**

**This SAFETY & INSTRUCTION
MANUAL should always accompany
this firearm and be transferred with it
upon change of ownership or when the
firearm is presented to another person.**

**Always keep your firearm pointed in a
safe direction. Never point a firearm at
anything you do not intend to shoot.**

**If you don't have a manual, printed
copies are available free upon request
by contacting the factory at the address
below. They are also available via
download from the company's web site
shown below.**

**THOMPSON/CENTER ARMS COMPANY, INC.
• CUSTOMER SUPPORT •
2100 Roosevelt Avenue • Springfield, MA 01104
TEL. Toll Free (866) 730-1614
www.tcarms.com**

YOUR SAFETY RESPONSIBILITIES	3
SAFE STORAGE & TRANSPORTATION.....	8
SAFETY RULES FOR THE OMEGA MUZZLELOADER.....	10
BASICEQUIPMENT FOR SHOOTING THE T/C OMEGA	13
UNDERSTANDING BLACK POWDER.....	14
UNDERSTANDING PYRODEX®	15
OMEGA TRIGGER & HAMMER	16
PREPARATION FOR FIRING	17
SERIAL NUMBER & MODEL I.D.	18
INSPECTING	19
CHARGING THE OMEGA MUZZLELOADER	20
PRIMING THE OMEGA MUZZLELOADER	26
FIRING THE OMEGA	28
UNLOADING AND UNCHARGING	30
FIELD CLEANING.....	32
THOROUGH CLEANING.....	34
DISASSEMBLY OF THE OMEGA MUZZLELOADER.....	36
MOUNTING A SCOPE.....	39
SIGHT ADJUSTMENT.....	40
LIMITED LIFETIME WARRANTY	41
CONTACT & SHIPPING FOR SERVICE	42
LOAD COMPONENTS	43
SUGGESTED LOADS FOR THE T/C OMEGA	44
FOR YOUR RECORDS	51

YOUR SAFETY RESPONSIBILITIES

SAFETY IS YOUR NUMBER ONE RESPONSIBILITY!!!!

At home, in the field, at the range, or anywhere, the first concern of every firearm owner should be safety. Apply the following safety rules in every situation, with any kind of firearm. If you feel uncertain about any operational aspects of your firearm, please contact Thompson/Center before proceeding with its operation.



WARNING: YOU MUST FOLLOW ALL OF THESE SAFETY RULES TO ENSURE THE SAFE USE OF YOUR FIREARM. THE FAILURE TO FOLLOW THE INSTRUCTIONS AND WARNINGS IN THIS MANUAL COULD CAUSE SERIOUS PERSONAL INJURY OR DEATH TO YOU OR OTHERS AND DAMAGE TO PROPERTY.

As a firearm owner, you accept a demanding responsibility. How seriously you take this responsibility can be the difference between life and death. There is no excuse for careless or abusive handling of your firearm. At all times handle your firearm with intense respect for its power and potential danger.

YOUR SAFETY RESPONSIBILITIES CONT'D

- **ALWAYS KEEP YOUR FIREARM POINTED IN A SAFE DIRECTION.** Never point a firearm at anyone or anything you do not intend to shoot whether or not it is loaded. This is particularly important when loading, unloading, or field stripping the gun. ALWAYS control the direction of the firearm.
- **ALWAYS TREAT EVERY FIREARM AS IF IT IS LOADED AND WILL FIRE.** Do not take anyone's word that the firearm is uncharged or unprimed – always check for yourself. Never pass your firearm to another person until the action is open and/or on safe, and you visually check that it is uncharged and unprimed. Keep your muzzleloading firearm uncharged and unprimed and safely stored when not in use.
- **NEVER PLACE YOUR FINGER INSIDE THE TRIGGER GUARD OR ON THE TRIGGER UNLESS YOU INTEND TO FIRE.** Ensure that other objects do not touch the trigger.
- **ALWAYS BE SURE OF YOUR TARGET AND WHAT IS BEYOND IT.** Always be sure of where the bullet will strike and shoot only where there is a safe back stop free of obstructions, water or other surfaces which can cause ricochets. Be sure your bullet will stop behind your target. Bullets can glance off many surfaces like rocks or the surface of water and travel in unpredictable directions with considerable velocity. Do not fire randomly into the sky.
- **NEVER CROSS OBSTACLES SUCH AS FENCES OR STREAMS WITH A CHARGED OR PRIMED MUZZLELOADING FIREARM.** Always make certain your muzzleloading firearm is unprimed before crossing a fence, climbing a tree, jumping a ditch or negotiating other obstacles.
- **SAFE FIREARM HANDLING IS YOUR PERSONAL RESPONSIBILITY AT ALL TIMES.** Firearms can be dangerous and can cause serious injury or death if they are misused or used inappropriately. Safety must be the prime consideration of any one who owns or handles firearms. Accidents are the result of violating the rules of safe firearm handling and common sense. Firearm safety training is available. Contact your firearms dealer, law enforcement agency, local sportsman's club, the NRA, etc. for availability.
- **YOU ARE RESPONSIBLE FOR THE FIREARM AT ALL TIMES.** In owning a firearm, you must undertake full-time responsibility for your firearm's safety and security. You must protect yourself and all others against injury or death from misuse of the firearm 24 hours a day.
- **FIREARM SECURITY IS YOUR RESPONSIBILITY.** You must secure firearms safely from children and/or unauthorized users. Your firearm should always be kept unloaded and locked when not in use. Never assume that the use of a lock is sufficient to safely secure your firearm. You must always evaluate your personal situation and employ the security systems that meet your needs and prevent children and unauthorized users from gaining access to your firearm.

YOUR SAFETY RESPONSIBILITIES CONT'D

- **APPROPRIATE USE FOR YOUR FIREARM MEANS USING YOUR FIREARM FOR LEGAL PURPOSES.** For example - target shooting, hunting and lawful resistance of deadly criminal force. It is your responsibility to ensure that you are in compliance with all applicable laws and ordinances regarding the use of your firearm.
- **NEVER RELY ON MECHANICAL FEATURES ALONE.** Only your safe firearm-handling habits will ensure the safe use of your firearm. This is your responsibility.
- **ALWAYS SAFELY STORE AND SECURE YOUR FIREARM.** Safe and secure storage of your firearm is one of your most important responsibilities. It is a full-time responsibility. You must always secure your firearm, ammunition, and loading components separately so that they are not accessible to children and/or other unauthorized persons.
- **NEVER KEEP AMMUNITION AND LOADING COMPONENTS IN THE SAME LOCATION AS THE FIREARM.** Store each in a separate and secure place.
- **ALWAYS WEAR EYE PROTECTION THAT IS SPECIFIED FOR USE WITH FIREARMS** every time you handle your firearm for cleaning and maintenance.
- **ALWAYS WEAR EYE AND EAR PROTECTORS THAT ARE SPECIFIED FOR USE WITH FIREARMS** every time you discharge your firearm. Make sure others in the vicinity of where you will be shooting do so as well.
- **NEVER USE ALCOHOL OR DRUGS BEFORE OR WHILE SHOOTING.** Do not use your firearm if you are on any medication which impairs, even slightly, your mental or physical ability.
- **ALWAYS HAVE ADEQUATE VENTILATION.** Discharging firearms in poorly ventilated areas, cleaning firearms, or handling ammunition and loading components may result in exposure to lead and other substances known to cause birth defects, reproductive harm, and other serious physical injury. Review the warnings and labels for all ammunition, loading components, and cleaning products carefully. Wash hands thoroughly after exposure.
- **BEFORE HANDLING ANY FIREARM, UNDERSTAND ITS OPERATION.** Not all firearms are the same. Familiarize yourself with the mechanical features of any firearm you intend to use. If you feel uncertain about any operational aspects of your firearm, please contact Thompson/Center before proceeding with its operation.
- **NEVER ALLOW A FIREARM TO BE USED BY INDIVIDUALS WHO DO NOT UNDERSTAND ITS SAFE OPERATION OR HAVE NOT READ THESE FIREARM SAFETY RULES.**

YOUR SAFETY RESPONSIBILITIES CONT'D

- **ALWAYS USE THE CORRECT COMBINATION OF LOAD COMPONENTS FOR YOUR PARTICULAR MUZZLELOADING FIREARM** as detailed in this manual.
- **BE CERTAIN THE BARREL IS CLEAR OF OBSTRUCTIONS BEFORE SHOOTING.** Mud, water, snow or other objects may inadvertently lodge in the barrel bore. A small obstruction can cause a dangerous increase in pressure and may damage your firearm and cause injury to yourself and others.
- **BE SURE ALL ACCESSORIES, SUCH AS HOLSTERS, GRIPS, SLINGS, SCOPES AND OTHER ACCESSORIES ARE COMPATIBLE** with the firearm and that the accessories do not interfere with safe operation. It is your responsibility to understand and follow all of the instructions in this manual, as well as those which may be supplied with your ammunition and loading components and any accessory.
- **NEVER DISASSEMBLE YOUR FIREARM** beyond the procedures outlined in this manual. Improper disassembly or re-assembly of your firearm may be dangerous and can lead to serious injury or death.
- **NEVER MANIPULATE, ADJUST OR CHANGE ANY OF THE INTERNAL COMPONENTS OF YOUR FIREARM UNLESS SPECIFICALLY INSTRUCTED TO DO SO IN THIS MANUAL.** Improper manipulation of any other internal component may affect the safety and reliability of your firearm and may cause serious injury or death.
- **NEVER ALLOW ANY ALTERATION OR REPLACEMENT OF PARTS IN YOUR THOMPSON/CENTER FIREARM UNLESS PERFORMED BY A QUALIFIED GUNSMITH** using genuine Thompson/Center parts. If you do otherwise, improper functioning of your firearm may occur and serious injury or death and damage to property may result.



WARNING: SAFE USE OF A FIREARM IS YOUR PERSONAL RESPONSIBILITY AND THE FAILURE TO FOLLOW ALL OF THESE BASIC SAFETY RULES MAY RESULT IN SEVERE PERSONAL INJURY OR DEATH TO YOU OR OTHERS AND DAMAGE TO PROPERTY. YOU ARE THE MOST IMPORTANT SAFETY DEVICE WHEN IT COMES TO THE USE OF YOUR FIREARM AND THOMPSON/CENTER WILL NOT BE RESPONSIBLE FOR ANY PERSONAL INJURY, DEATH OR PROPERTY DAMAGE THAT RESULTS FROM: (1) THE CRIMINAL OR NEGLIGENT USE OF THIS FIREARM; (2) A DISREGARD OF THESE SAFETY INSTRUCTIONS AND WARNINGS; (3) IMPROPER OR CARELESS HANDLING OF THIS FIREARM; (4) THE USE OF NON-STANDARD, DEFECTIVE, IMPROPER LOAD COMPONENTS, OR (5) IMPROPER OR NEGLIGENT MODIFICATIONS OR REPAIRS TO THE FIREARM.

YOUR SAFETY RESPONSIBILITIES CONT'D

- **NEVER CLIMB TO OR DESCEND FROM A TREE STAND WITH A PRIMED MUZZLELOADING FIREARM. NEVER RAISE OR LOWER A PRIMED MUZZLELOADING FIREARM TO OR FROM A TREE STAND.** Failure to follow this rule may cause serious injury and/or death to the shooter or bystanders and damage to property.
- **NEVER LEAN A CHARGED AND PRIMED RIFLE AGAINST A TREE, A WALL OR ANY SURFACE WHERE IT MAY FALL OVER.** Once the rifle has been charged it is your responsibility to guard against situations that may result in an accidental discharge. Failure to follow this rule may cause serious injury and/or death to the shooter or bystanders and damage to property.
- **USE THOMPSON/CENTER SCOPE MOUNTS ONLY.** The current product catalog lists a series of scopes and mounts which are designed specifically for use with our firearms. These mounts make use of existing screw holes. Those who desire a scope sight should make use of Thompson/Center mounts. Do not drill additional holes in the barrel as this could weaken the barrel structure leading to a rupture. A ruptured barrel can cause serious injury and/or death to the shooter or bystanders and damage to property.

WARNING: DO NOT DRILL HOLES IN THE BARREL AS THIS COULD WEAKEN THE BARREL STRUCTURE LEADING TO A RUPTURE. A RUPTURED BARREL CAN CAUSE SERIOUS INJURY AND/OR DEATH TO THE SHOOTER OR BYSTANDERS AND DAMAGE TO PROPERTY. DRILLING HOLES IN THE BARREL ALSO VOIDS ALL WARRANTIES.

- **NEVER MODIFY ANY OF THE PARTS IN YOUR FIREARM.** Do not add or replace any of the parts in your firearm unless they are genuine Thompson/Center parts and you follow the instructions supplied by Thompson/Center. If you do otherwise, improper functioning may occur and serious injury or death may result. In addition to the dangers presented, the use of non-factory parts, including but not limited to, stocks and springs, voids all warranties.



WARNING: NEVER RELY ON MECHANICAL SAFETY FEATURES OF THE FIREARM ALONE. ONLY YOUR SAFE FIREARM HANDLING WILL ENSURE THE SAFE USE OF YOUR FIREARM. THIS IS YOUR RESPONSIBILITY.

SAFE STORAGE & TRANSPORTATION



WARNING: ALWAYS POINT THE MUZZLE IN A SAFE DIRECTION.



WARNING: FIREARMS ARE DANGEROUS WHEN USED AND STORED IMPROPERLY. THEY POSE A RISK OF SERIOUS OR FATAL INJURIES. FIREARMS CAN BE ESPECIALLY DANGEROUS TO CHILDREN WHEN THEY ARE STORED IN AN IRRESPONSIBLE AND UNSAFE MANNER. FOR YOUR SAFETY AND THE SAFETY OF OTHERS, IT IS IMPERATIVE THAT YOU KEEP YOUR FIREARM LOCKED AND UNLOADED IN A SECURE PLACE. THE AMMUNITION AND LOADING COMPONENTS SHOULD BE STORED IN A SEPARATE, SECURE LOCATION WHEN IT IS NOT IN USE. SAFE AND SECURE STORAGE OF YOUR FIREARM IS ONE OF THE MOST IMPORTANT RULES OF FIREARM SAFETY. YOUR FAILURE TO FOLLOW THESE RULES MAY RESULT IN SERIOUS INJURY OR DEATH TO YOU OR OTHERS.

- **ALWAYS SECURE YOUR FIREARM IN A MANNER THAT WILL PREVENT UNAUTHORIZED ACCESS.** Whenever your firearm is not in use, keep it unloaded and locked. Your safety and the safety of others requires that you always secure and store your firearm in a manner that will prevent unauthorized access. Never leave a firearm unattended unless it is locked, unloaded and secured.



WARNING: NEVER LOCK A LOADED FIREARM AND NEVER LOAD A LOCKED FIREARM!!

- **ALWAYS STORE YOUR FIREARM AND AMMUNITION AND LOADING COMPONENTS SEPARATELY** so that they are not accessible to children or other unauthorized persons. Safe and secure storage of your firearm, ammunition, and loading components is your responsibility. It is a full-time responsibility.
- **NEVER ASSUME THAT A “HIDING” PLACE IS A SECURE STORAGE METHOD.** Others may be aware of your storage location or come upon it by chance. It is your personal responsibility to use common sense when storing your firearm and ammunition and loading components and to always make sure they are not accessible to children or other unauthorized persons.
- **NEVER TRANSPORT A CHARGED OR PRIMED MUZZLE-LOADING FIREARM.** When transporting your firearm, be sure it is uncharged, unprimed and securely locked. Safe and secure transportation of your firearm is your responsibility.

SAFE STORAGE & TRANSPORTATION CONT'D

- **ALWAYS FOLLOW THE LAW!** Many jurisdictions have laws that make it a crime to keep a firearm unlocked and in an area accessible to children or others. Keeping a firearm locked and unloaded when not in use is not only common sense safety practice... IT IS THE LAW. You must be familiar with all local, state, and federal laws regarding the safe storage and transportation of your firearm. Failure to know and follow the law may result in unauthorized access or use of your firearm by another. Obey all laws relating to the storage and transportation of firearms. Your local police department or gun shop can furnish you with available information on storing and/or transporting a firearm safely and legally.
- **YOUR FIREARM IS YOUR RESPONSIBILITY.** You must prevent your firearm from being stolen or from being used by untrained or unqualified individuals. Keep it locked, uncharged, unprimed and secured when not in use.

SAFETY RULES FOR THE OMEGA MUZZLELOADER

In addition to the general Firearm Safety Responsibilities covered so far in this manual, there are additional guidelines specific to black powder muzzleloading firearms that must be adhered to at all times to ensure the safety of the shooter and others.

- **NEVER USE SMOKELESS POWDER OF ANY TYPE OR IN ANY QUANTITY IN A MUZZLELOADING FIREARM, AND NEVER MIX POWDERS.** The use of any smokeless powder could result in a detonation or explosion which could cause injury and/or death to the shooter or bystanders and damage to property.
- **USE ONLY BLACK POWDER OR AN APPROVED BLACK POWDER SUBSTITUTE SUCH AS PYRODEX® TO LOAD YOUR MUZZLELOADING FIREARM.** Never use even small amounts of smokeless powder, even if it is black in color. The use of any other propellant may cause injury or death to the shooter or bystanders and damage to property.
- **NEVER SMOKE WHILE USING YOUR MUZZLELOADER.** The spark from a lighted cigarette, cigar or pipe can ignite Black Powder or a Black Powder substitute such as Pyrodex, and Percussion Caps or Primers. Smoking around a charged and/or primed muzzleloader, percussion caps, primers, priming powder or supply of powder may cause premature firing of the firearm or an explosion of the powder can, horn or flask causing serious injury and/or death to the shooter or bystanders and damage to property.
- **BEFORE LOADING, MAKE SURE THE MUZZLELOADING FIREARM IS NOT ALREADY CHARGED.** To make sure it is uncharged, keep the muzzle pointed in a safe direction and insert the ramrod provided with the rifle into the bore. Note the position of the ramrod in relation to the muzzle. It will be slightly below the end of the barrel if the rifle is not loaded.
- **NEVER EXCEED THE RECOMMENDED MAXIMUM CHARGE LISTED IN THIS BOOK.** To do so could result in injury or death to the shooter or bystanders.
- **WHEN LOADING, BE CERTAIN THAT THE PROJECTILE IS LOADED IN THE PROPER SEQUENCE AND THAT IT IS SEATED FIRMLY AGAINST THE POWDER CHARGE.** Serious personal injury or death can result if the projectile is not seated properly. To provide a reference mark for future loadings, mark the ramrod at the muzzle once a projectile has been loaded to the proper depth. NOTE: Be sure to recheck the ramrod mark if you change loading components or alter the ramrod.

T/C OMEGA SAFETY RULES CONT'D

- **NEVER POUND ON THE RAMROD.** Black Powder and approved Black Powder substitutes such as Pyrodex® are potentially sensitive to impact and could ignite from impact. Always keep the muzzle directed away from your face or body when loading.
- **BLACK POWDER AND BLACK POWDER SUBSTITUTES SUCH AS PYRODEX® LEAVE CORROSIVE RESIDUES IN THE BORE AND ON THE FIREARM.** A thorough cleaning is absolutely necessary before storage for any amount of time to keep the firearm functioning correctly and in safe a condition.
- **UNDERSTAND THE TERMINOLOGY.** “Charge” or “Charged” applies to the presence of a propellant powder charge and projectile in the bore of the muzzleloading firearm.
- “Uncharge” or “Uncharged” refers to the opposite condition to “Charged” and indicates that the powder charge and projectile have been either fired or removed and that the bore is completely clear.
- “Prime” or “Primed” applies to the act of placing a primer, cap or priming powder in or on a muzzleloader.
- “Unprime” or “Unprimed” refers to the opposite condition of “Primed” and indicates that the primer, cap or priming powder has been removed from the firearm or is not in place.
- **NEVER PRIME YOUR MUZZLELOADING FIREARM UNTIL YOU ARE READY TO FIRE IT.** Your muzzleloader should remain unprimed until the instant before firing. After you prime the firearm, your full concentration should be on the target and the act of firing.
- **A SHARP OR HEAVY BLOW TO THE EXTERNAL HAMMER CAN FRACTURE PARTS AND CAUSE A MALFUNCTION OR DISCHARGE OF THE FIREARM.** An accidental discharge may cause serious injury and/or death to the shooter or bystanders and damage to property.
- **NEVER HAND A CHARGED MUZZLELOADING FIREARM TO ANOTHER PERSON.** Once charged, a muzzleloading firearm requires your complete attention. Never charge the firearm and then hand it to another shooter. Equally, you should never shoot a muzzleloading firearm that has been charged by someone else. Only the person doing the loading knows whether the firearm has been charged properly.

T/C OMEGA SAFETY RULES CONT'D

- **DO NOT CHARGE YOUR T/C MUZZLELOADER DIRECTLY FROM A CAN, HORN OR FLASK.** A spark from a previous firing may ignite the stream of powder being poured into the firearm and cause the container to explode. The explosion of a powder can, horn or flask may cause serious injury and/or death to the shooter or bystanders and damage to property. Use a separate pre-calibrated measuring device containing small quantities of powder to charge your firearm. Keep the muzzle directed away from your face and body when loading.
- **ALWAYS KEEP SUPPLIES OF POWDER, PRIMERS AND CAPS WELL AWAY FROM A FIRING POSITION OR SHOOTING BENCH.** A powder horn, flask, can of powder, or quantity of primers or caps can ignite with deadly force if exposed to sparks or intense heat. Follow the manufacturer's instructions for safe handling and storage of powder and primers or caps. Keep unused powder and primers or caps well away from firearms that are being discharged. Sparks from the discharge of a muzzleloading firearm may cause an unused supply of powder or primers or caps to ignite causing serious injury and/or death to the shooter or bystanders and damage to property.
- You must follow this procedure every time a firearm leaves your hand, is cleaned, handed to you or another person, transported or stored.



WARNING: NEVER RELY ON MECHANICAL FEATURES ALONE. ONLY YOUR SAFE FIREARM HANDLING WILL ENSURE THE SAFE USE OF YOUR FIREARM. THIS IS YOUR RESPONSIBILITY.

BASIC EQUIPMENT FOR SHOOTING THE T/C OMEGA

In order to shoot your Thompson/Center Omega muzzleloader, you will need the following accessories or equipment listed below:



WARNING: DO NOT ATTEMPT TO SHOOT YOUR MUZZLELOADING FIREARM UNTIL YOU HAVE READ THIS MANUAL IN ITS ENTIRETY AND UNDERSTAND IT FULLY. FAILURE TO READ AND FOLLOW THESE INSTRUCTIONS COULD RESULT IN INJURY AND/OR DEATH TO THE SHOOTER OR BYSTANDERS AND DAMAGE TO PROPERTY. IF YOU ARE UNABLE TO UNDERSTAND ANY OR ALL OF THIS MATERIAL, CALL THE CUSTOMER SERVICE DEPARTMENT AT THOMPSON/CENTER.

1. Proper eye protection - specified for use with firearms.
2. Proper ear protection - specified for use with firearms.
3. Black Powder or an approved Black Powder substitute such as Pyrodex[®], in the appropriate type for your firearm.
4. A Powder Measure.
5. Projectiles: Appropriate for your firearm.
6. 209 Primers.
7. Bore cleaning patches.
8. A Jag to hold cleaning patches.
9. An appropriate bore cleaner for muzzleloaders (like T/C's Number 13[®] Bore Cleaner).
10. An appropriate oil or rust inhibiting lubricant (like T/C's Natural Lube 1000 Plus[™] Bore Butter).

UNDERSTANDING BLACK POWDER



Shooting muzzleloading firearms requires the shooter to be both a reloader and a rifleman at the same time. It requires strict adherence to the instructions set forth in this booklet. Failure to follow these instructions may cause damage to the firearm and injury and/or death to the shooter or bystanders and damage to property.

NOTE: Black Powder is manufactured in four specific types or granulations for use in firearms. Generally speaking, it is the granule size which determines the appropriate use of Black Powder. The largest granulations are naturally the slowest burning and, therefore, work best in large caliber rifles and shotguns. Pistols or smaller caliber rifles require a finer or faster burning powder. The priming powder used in the pan of a flint lock is extremely fine and fast burning for positive ignition of the main charge.

FG (commonly called Single “F”)

The muzzleloading enthusiast finds little use for this very coarse black powder. It's use is restricted to the large bore (10, 8, 4 gauge) shotguns of yesteryear.

FFG (commonly called Double “F”)

This is a very popular powder for .45 caliber to .58 caliber rifles. It is also used for 12, 16, and 20 gauge muzzleloading shotguns. While it is not considered a pistol powder, it is sometimes used in very large caliber single shot pistols. It is recommended for use in most T/C muzzleloaders.

FFFG (commonly called Triple “F”)

Due to its wide range of uses, Triple “F” is the black powder that is most commonly found on a dealer's shelf. It is used in all percussion revolvers, most single shot pistols, and most of the smaller (under .45 caliber) rifles. It can also be used to prime a flint lock if no 4F powder is available for that purpose.

FFFFG (commonly called Four “F”)

The finest of all currently available black powders, Four “F” is best used for priming flint locks. Due to its limited use, it is sometimes difficult to obtain.

When purchasing Black Powder be certain that it is in the original manufacturer's container and that its granulation or type is clearly marked on the label. Follow the storage and handling precautions which are on the label. If you have any questions concerning the safe handling or storage of Black Powder, write to the manufacturer of the powder. Additional information on powder storage is available from the National Fire Protection Association, P.O. Box 9146, Quincy, Mass. 02269. Or call 1-800-344-3555. Ask for pamphlet #495.

UNDERSTANDING PYRODEX®



Pyrodex® is a propellant powder designed for use in muzzleloading cap lock rifles, pistols and shotguns. Pyrodex is not Black Powder. In accordance with the manufacturer's instructions, Pyrodex relates closely to Black Powder on a volume to volume basis (not weight of charge). In other words, a black powder measure that is set to dispense 70 grains of black powder will, in fact, dispense approximately 52 grains of Pyrodex (by weight). This lighter charge of Pyrodex will provide a

charge which is ballistically similar to 70 grains of Black Powder. For all practical purposes, knowing the actual weight of a charge of Pyrodex may be informative, but not necessary. Your black powder measure will dictate the proper amount by its graduations according to volume. If you want to know the actual comparative weight of a Pyrodex charge, contact the manufacturer, Hodgdon Powder Co. Inc., 6231 Robinson, Shawnee Mission, KS 66202-1332.

Pyrodex® does not ignite as easily as Black Powder and, consequently, it is not recommended for use in flint lock firearms. Flint locks require strong, positive ignition and should be charged and primed with Black Powder of the appropriate granulation only.

PYRODEX® CTG - FOR BLACK POWDER CARTRIDGES.

This powder was designed to be used in breech loading cartridge firearms (rifles, pistols & shotguns) which were intended for use with Black Powder. It has no application in Thompson/Center muzzle-loading firearms. It is listed here simply for identification purposes.

PYRODEX® RS (or PYRODEX SELECT "RS") RIFLE & SHOTGUN POWDER. Designed for use in all calibers of percussion muzzleloading rifles and shotguns, this powder has a wide application. It may be used with all Thompson/Center muzzleloading rifles and shotguns. Pyrodex Select (RS) may also be used in these applications.

PYRODEX® P - PISTOL POWDER. Designed for use in most percussion muzzleloading pistols and cap and ball revolvers, this powder has application in the Thompson/Center Patriot™ Pistol.

PYRODEX® PELLETS - These pre-formed charges are designed for use in most Thompson/Center muzzleloaders and are suitable where permitted by state and local laws. Use the appropriate caliber and charge weight pellet for your muzzleloading rifle.

The reader should bear in mind that Thompson/Center does not manufacture or sell powder of any type. If there is ever a question as to the proper application of a particular powder or the safety of a given charge, write to the manufacturer of the powder. Adhere to the safe handling and storage precautions printed on the manufacturer's container and never purchase or use powders which have been removed from their original container. **USE OF THE WRONG PROPELLANT** may cause injury and/or death to the shooter or bystanders and damage to property. For information on Pyrodex write to Hodgdon Powder Co., Inc., 6231 Robinson, Shawnee Mission, KS 66202-1332.

OMEGA TRIGGER & HAMMER



WARNING: THE FAILURE TO FOLLOW THESE FIREARM SAFETY REQUIREMENTS WILL CAUSE SERIOUS PERSONAL INJURY OR DEATH TO YOU OR OTHERS.

There are three hammer positions on the T/C Omega; At Rest, Cocked and "Fired"

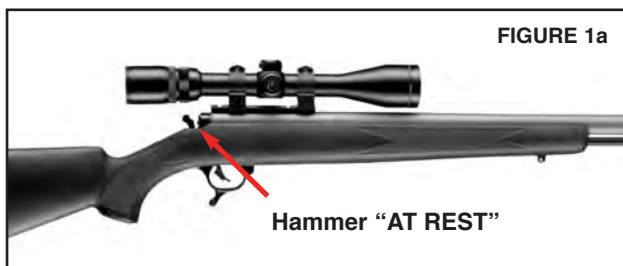

- **THE HAMMER SHOULD BE IN THE "AT REST" POSITION DURING LOADING AND WHEN CARRYING.**

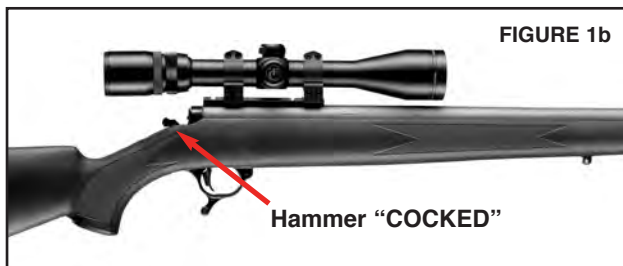

- **THE HAMMER SHOULD BE IN THE "COCKED" POSITION ONLY WHEN IN THE PROCESS OF FIRING.**

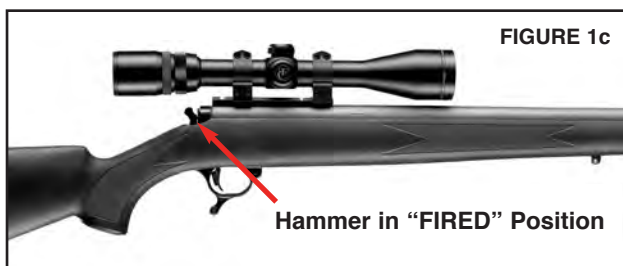

- **WHEN THE OMEGA IS COCKED AND THE TRIGGER IS PULLED - THE HAMMER CONTACTS THE FIRING PIN.**

PREPARATION FOR FIRING



WARNING: THE FAILURE TO FOLLOW THESE FIREARM SAFETY REQUIREMENTS MAY CAUSE SERIOUS PERSONAL INJURY OR DEATH TO YOU OR OTHERS.

- **ALWAYS TREAT ALL FIREARMS AS IF THEY ARE LOADED AND WILL FIRE IF THE TRIGGER IS PULLED.**
- **ALWAYS WEAR ADEQUATE AND PROPER EAR PROTECTORS SPECIFIED FOR FIREARM USE** to prevent permanent damage to your hearing. Make sure others who are nearby are wearing ear protection as well.
- **ALWAYS WEAR PROPER CLOTHING WHEN FIRING A MUZZLELOADER.** Wearing long sleeves is recommended to protect arms from debris that may be ejected during firing.
- **ALWAYS WEAR SAFETY GLASSES SPECIFIED FOR FIREARM USE,** whether indoors or out. Safety glasses should protect your eyes from the firing flash and particles associated with the discharge of a muzzleloader. Failure to do so creates a risk of personal injury from particle or debris spitting or ricochets. Make sure others who are nearby are wearing eye protection as well.
- **ALWAYS BE ALERT AND ALWAYS FOLLOW THE SAFETY INSTRUCTIONS OF THE RANGE OFFICER.** Never shoot if you are tired, cold or impaired in any way.
- **ALWAYS BE AWARE OF OTHER PEOPLE** so that persons cannot accidentally walk into the line of fire.
- **THE SHOOTER (AND ALL OTHERS IN THE SHOOTING AREA) MUST ALWAYS BE IN A POSITION THAT IS OUT OF THE LINE OF FIRE** and are not within an area where they may be struck by ricochets or particles ejected from a firearm.
- **NEVER SHOOT AT HARD SURFACES, WATER OR RANDOMLY INTO THE SKY.** Always select a place to shoot that has a safe backstop and is free from obstructions and surfaces which cause ricochets.
- **NEVER USE ALCOHOL OR DRUGS BEFORE OR WHILE SHOOTING OR HANDLING ANY FIREARM.**
- **NEVER SMOKE WHILE SHOOTING OR HANDLING A MUZZLELOADING FIREARM.**
- **ALWAYS KEEP LOADING COMPONENTS AND LOADING RESERVES WELL AWAY FROM THE MUZZLELOADER WHEN FIRING.**

SERIAL NUMBER & MODEL I.D.

FIGURE 2a



FIGURE 2b

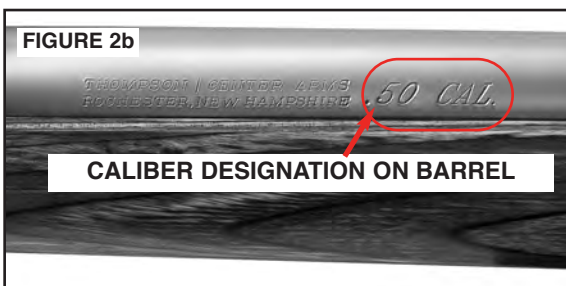

FIGURE 2c

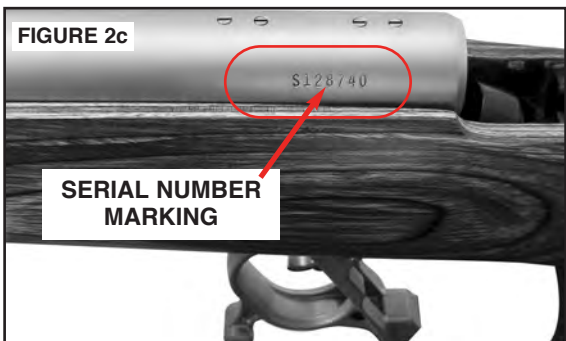

FIGURE 2d



INSPECTING



WARNING: ALWAYS KEEP THE MUZZLE POINTED IN A SAFE DIRECTION.



WARNING: ANY TIME THAT YOU HANDLE A OMEGA, OPEN THE ACTION AND ENSURE THAT IT IS UNCHARGED AND UNPRIMED.

INSPECTING

- With your finger away from the trigger and with the hammer in the “AT REST” position (Figure 3), open the action to inspect by pushing forward on the trigger guard spur (Figures 3 & 4).

- Look into the breech plug to make sure there is no primer present (Figure 5) and look through the breech plug channel to ensure that there is no charge in the bore.

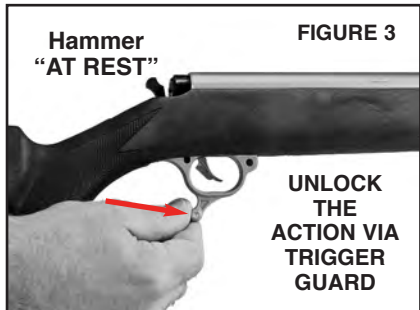

- Verify that the bore is clear and free of obstructions.

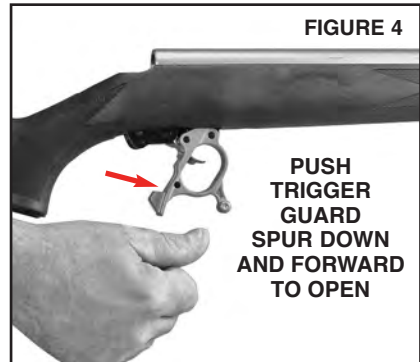

- You must follow this procedure every time a firearm leaves your hand, is cleaned, handed to you or another person, transported or stored.



WARNING: NEVER RELY ON MECHANICAL FEATURES ALONE. ONLY YOUR SAFE GUN HANDLING WILL ENSURE THE SAFE USE OF YOUR FIREARM. THIS IS YOUR RESPONSIBILITY.

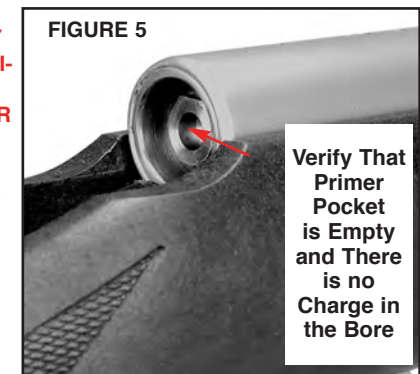

CHARGING THE OMEGA MUZZLELOADER



WARNING: ALWAYS KEEP THE MUZZLE POINTED IN A SAFE DIRECTION.

NOTE: The loading data found in this manual was compiled using Black Powder or Pyrodex as a propellant. With any other approved Black Powder substitute, follow the instructions supplied by the manufacturer and heed all warnings and instructions as they apply to loading and usage of that product.

- Inspect the bore for obstructions and oil or grease (and clean if necessary). This is true with the rifle as it comes from the factory, as it has been treated with anti-rust compound that needs to be cleared before use.
- Do not load the muzzleloading firearm until you have read and fully understand this manual.
- Do not load the muzzleloading firearm until you are ready to use it. Keep your finger off the trigger and outside the trigger guard until you are ready to fire.

Read this manual in its entirety before attempting to load your firearm. Improper loading and use of your firearm can cause injury and/or death to the shooter or bystanders and damage to property.

Study the photo on page 22 carefully and read all the captions before you charge your muzzleloading rifle. The photo shows a shooter in the process of loading an Omega muzzleloader.

To open the Omega - tip the trigger guard spur down and forward to unlock the action and allow the breech to pivot downward. Look into the breech plug primer pocket and check to make sure there is no primer present. Hold the muzzle up to the light and look through the ignition channel to ensure that there is no charge present. To close the Omega, pull the trigger guard up and back while securely holding the Omega by the forend with your other hand. Practice opening and closing the Omega before attempting to load and fire this firearm.

To make sure it is unloaded, keep the muzzle pointed in a safe direction and insert the ramrod provided with the rifle into the bore. Note the position of the ramrod in relation to the muzzle. It will be slightly below the end of the barrel if the rifle is not loaded. Commit this exercise to memory and practice it every time that you handle the Omega, or any other muzzleloader. Before you attempt to load it - before you store it away - before you hand it to a friend or leave it unattended, always check to ensure that the firearm is unprimed and uncharged.

CHARGING THE T/C OMEGA CONT'D

Wipe the bore free of all oil before loading. Be meticulous with your cleaning - for the presence of any amount of oil in the barrel or chamber can dampen the powder charge and cause the rifle to misfire or hangfire (see section on "Cleaning"). Point the muzzle in a safe direction and snap several 209 primers in the breech plug before charging. This will help ensure positive ignition and clear away any oil that may have accumulated in the ignition channel.

Adjust the powder measure to dispense the desired charge and fill it with Black Powder or an approved Black Powder substitute, such as Pyrodex. To achieve accuracy, consistency in the powder charge is required. Fill the measure exactly the same each time. Set the rifle on its butt and hold the muzzle away from your face and body as pictured on page 22. Pour the measured charge down the barrel and strike the side of the barrel several sharp raps with the heel of your hand. This will settle the powder into the chamber area of the barrel. If you are using pellets - follow the instructions provided by the pellet manufacturer. Seat the projectile firmly on top of the powder or pellets. Do Not pound on the ramrod or beat the projectile with excessive force, so as to crush the powder or pellet(s) and distort the bullet.

NOTE: Under normal conditions the Omega muzzleloader is unloaded simply by firing it into a suitable and safe backstop. There are, however, conditions under which the firearm cannot be fired and the charge must be removed manually:

- The projectile is not seated firmly against the powder charge, **stop immediately!** Do not attempt to fire the gun. You must remove the charge and then clean the barrel.
- The Omega muzzleloader is loaded in a proper manner yet fails to fire after repeated priming and clearing of the ignition fire channel.
- You are at a location that is unsuitable for discharging the firearm before transporting it.

Proceed to the section on **Unloading and Uncharging** in this manual if these conditions or any others occur where the muzzleloader cannot be discharged safely.

CHARGING THE T/C OMEGA CONT'D

WARNING: IMPROPERLY CHARGING YOUR T/C OMEGA MUZZLELOADER CAN BE DANGEROUS. STUDY THIS PHOTO CAREFULLY BEFORE PROCEEDING.

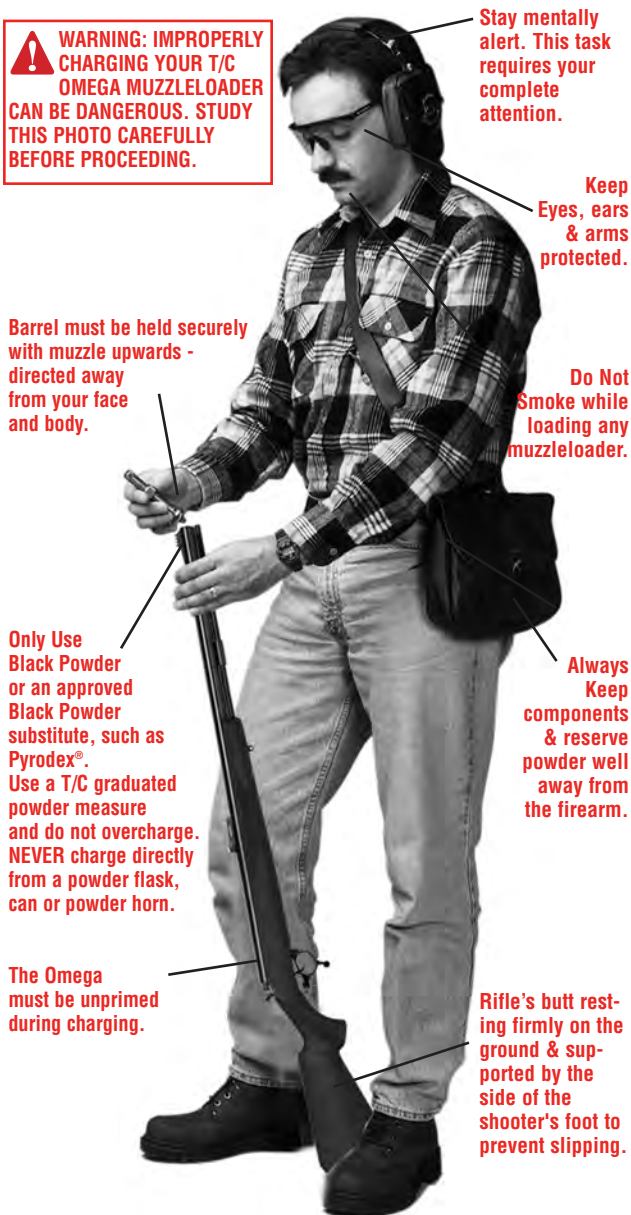

FIGURE 6

CHARGING THE T/C OMEGA CONT'D

Loading Conical Lead Bullets or Sabots When Using loose Black Powder or Granular Pyrodex®

The procedures for loading sabots or conical bullets when using loose Black Powder or loose Pyrodex® are basically the same. Care should be taken to seat the bullet or sabot firmly against the powder charge. Do not pound on it. Again, mark your ramrod at the muzzle, ensuring that each time you seat a bullet on the powder the projectile is seated to the same depth.

If you are loading an all-lead conical bullet like T/C's Maxi-Ball™ or Maxi-Hunter®, proceed as follows: do not use any kind of cloth patch with these projectiles. They should be lubricated prior to loading, and are designed to be shot as cast (not sized further). T/C Maxi-Ball™ and Maxi-Hunter® bullets come from the factory prelubricated. However, if you find some unlubricated bullets, we recommend that you lubricate these bullets with T/C Natural Lube 1000 Plus™ Bore Butter. When loading a Maxi-Ball™ or Maxi-Hunter® bullet into the muzzle, you will note how only the forward most bearing band grooves to the rifling when loading. The base of the bullet upsets (increases in diameter) upon firing, causing it to fill the grooves, thus stabilizing the projectile and aiding accuracy.

When loading sabots, do not lubricate them. They are intended to be loaded into the muzzleloader just as they come from the package. In fact, for best results, it is recommended that all evidence of oil or lubricant be removed from the bore before loading a sabot - the drier the bore the better in terms of optimal accuracy.

Hold the rifle as pictured on page 22 and pour your measured powder charge into the barrel. Start the lubricated bullet or sabot into the bore with your fingers. The base of the projectile will enter the bore easily with finger pressure. Drive the projectile down about four inches into the barrel with the rod end of the bullet starter (Figure 7). Using the ramrod, push the projectile the remainder of the way down the barrel until it contacts the powder charge. The sabot or bullet must be seated firmly against the powder charge. Seat the projectile with the same pressure shot after shot to aid in accuracy.



Remove the ramrod from the bore and return it to the thimble(s) under the barrel before you prime the firearm.

CHARGING THE T/C OMEGA CONT'D

Figure 8

Push the projectile down the barrel with the ramrod and seat it firmly against the powder charge.



FIGURE 8

Figure 9

Once the projectile is seated firmly against the powder charge, mark your ramrod to indicate the correct loaded depth of the powder plus the projectile. This will allow you to ensure that each projectile is seated to the same depth before firing. Re-mark the ramrod each time you adjust the powder charge or change projectiles.

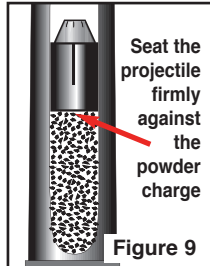

Figure 9

Figure 10

When you arrive at the desired charge, mark the ramrod so you have a permanent reference mark. When the powder charge or projectile are then changed, the reference mark should also be changed to indicate the new correct load length.



FIGURE 10

WARNING: NEVER FIRE A MUZZLELOADER UNLESS YOU ARE SURE THE PROJECTILE IS PROPERLY SEATED ON THE POWDER CHARGE AND THE RAMROD HAS BEEN REMOVED FROM THE BORE. SHOOTERS SHOULD BEAR IN MIND THAT THE MUZZLELOADING PROJECTILE IS NOT CRIMPED INTO POSITION AS IS THE FIXED CARTRIDGE PROJECTILE. IF A PROJECTILE DOES NOT FIT TIGHTLY THEN JARRING OR MOVEMENT OF THE FIREARM CAN CAUSE IT TO MOVE FORWARD IN A MUZZLELOADER. IF THE FIREARM IS FIRED WHEN A PROJECTILE IS FORWARD OR OFF THE POWDER CHARGE, OR THE RAMROD IS STILL IN THE BORE, THEN THE PROJECTILE OR RAMROD MAY ACT AS A BORE OBSTRUCTION. THIS CAN CAUSE A RUPTURED OR BURST BARREL. A RUPTURED OR BURST BARREL MAY CAUSE INJURY AND/OR DEATH TO THE SHOOTER OR BYSTANDERS AND DAMAGE TO PROPERTY. IF, DUE TO FOULING, A BULLET OR BALL BECOMES LODGED PART WAY DOWN THE BARREL, THE FIREARM MUST BE DISASSEMBLED AND THE CHARGE REMOVED. SEE SECTION ON "CLEANING." ALSO SEE SECTION ON "UNLOADING AND UNCHARGING."

CHARGING THE T/C OMEGA CONT'D

Loading Conical Bullets or Sabots When Using Pyrodex® Pellets

Start by loading the pellets into the bore, following the specific pellet manufacturer's instructions.

Next, start the projectile into the bore with a bullet starter and then use your ramrod to push the projectile the remainder of the way down the bore, until it is seated firmly against the pellet(s) (Figure 11). Do not pound on it, as this will likely crush the pellets and effect the reliability of ignition. It could also deform the bullet and will undoubtedly affect accuracy.

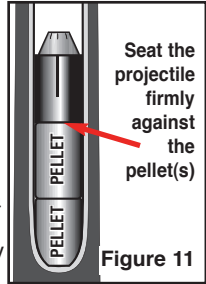

With successive shots, fouling may build up enough in the bore to make loading of subsequent shots more difficult, or even impossible. The more fouling that is present, the more difficult it will be to seat your projectile to the same depth. This will cause differences in pressure, which will in turn affect accuracy. While at the range, you should clean (swab) your bore (with a cleaner like Thompson/Center's Number 13® Bore Cleaner and suitable jag/patch combination) after each shot, for maximum accuracy. In the field, you can expect to fire two to three shots before swabbing may be necessary. The more powder you use in each charge, the more fouling will build up. When you experience progressively more difficult bullet seating due to buildup of fouling, you must clean the bore or safe loading will become impossible. See the sections on "Cleaning" and on "Unloading/Uncharging."

Once the sabot has been loaded, carefully mark your ramrod to indicate the correct depth of the fully seated pellet and projectile combination that you are using (Figure 12) so you can seat each subsequent to the correct depth.

If you are loading sabots, make sure that the bore has been cleaned and that all of the oil or lubricant has been removed. The drier the bore, the better when shooting sabots, as this will improve accuracy.



PRIMING THE OMEGA MUZZLELOADER

The Thompson/Center Omega muzzleloading rifle uses a 209 primer for ignition.



WARNING: ALWAYS POINT THE MUZZLE IN A SAFE DIRECTION.



WARNING: DO NOT PRIME THE FIREARM UNTIL YOU ARE ACTUALLY READY TO FIRE AND YOU HAVE DOUBLE CHECKED TO ENSURE THAT THE RAMROD HAS BEEN REMOVED FROM THE BORE. THOMPSON/CENTER DOES NOT RECOMMEND PRIMING THE FIREARM UNTIL THE INSTANT BEFORE FIRING. CARRYING A CHARGED, PRIMED OMEGA CAN BE DANGEROUS. ACCIDENTAL DISCHARGE IS A CONSTANT HAZARD WHICH, IF IT OCCURS, CAN CAUSE INJURY AND/OR DEATH TO THE SHOOTER OR BYSTANDERS AND DAMAGE TO PROPERTY. THE ONLY SAFE WAY TO GUARD AGAINST AN ACCIDENTAL DISCHARGE IS TO CARRY YOUR T/C OMEGA UNPRIMED, WITH THE HAMMER IN THE "AT REST" POSITION AND THE MUZZLE POINTED DOWNRANGE AWAY FROM YOURSELF, BYSTANDERS OR PROPERTY.

If you have followed the preceding instructions in this manual, your firearm will now be charged with Black Powder or an approved Black Powder substitute such as Pyrodex® and a projectile will be firmly seated against the powder charge. The ramrod will be returned to the thimbles under the barrel and your ramrod will be marked to the exact seating depth of the powder/projectile combination that you are using - allowing you to ensure that each future projectile is also seated to the same depth in the bore.

With the muzzle pointed in a safe direction, open the action by pivoting the trigger guard down and forward.

PRIMING THE T/C OMEGA CONT'D

WHEN YOU ARE READY TO FIRE YOUR OMEGA, OPEN THE ACTION AND PRIME IT AS SHOWN (Figure 13).

Showing a #209 Primer being placed in the breech plug.

FIGURE 13

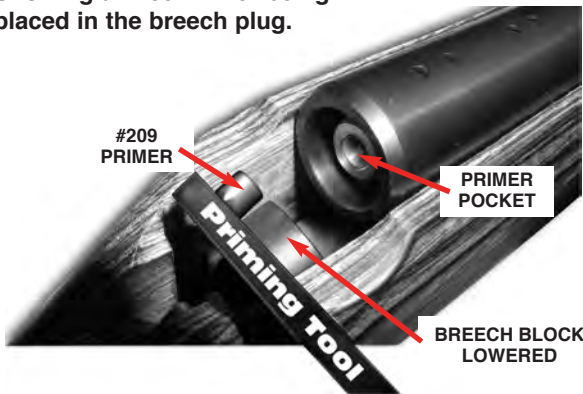

Keep muzzle pointed downrange, keep fingers away from trigger.

Handling 209 primers can be made easier with the (Figure 14) primer/deprimer tool (T/C part #7802). Slide a 209 primer into the slot of the tool as shown in the diagram below. To prime the gun, place the protruding part of the primer into the hole in the breech plug. Once the primer has been inserted, pull the tool away from the gun while leaving the 209 primer in the breech plug's primer pocket. To remove a 209 primer from the breech plug, push this forked end under the rim of the primer. As you push the tool forward, the primer will lift out of its hole allowing you to grasp the primer with your fingers and remove it from the gun.

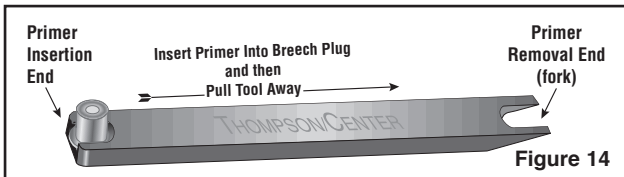

Figure 14

If you decide not to fire; make sure the gun is always pointed in a safe direction and remove the 209 primer from the breech plug primer pocket.

FIRING THE OMEGA



WARNING: ALWAYS KEEP THE MUZZLE POINTED IN A SAFE DIRECTION.



WARNING: WEAR EYE AND EAR PROTECTION SPECIFIED FOR FIREARM USE EVERY TIME YOU DISCHARGE YOUR FIREARM. MAKE SURE OTHERS IN THE VICINITY OF WHERE YOU WILL BE SHOOTING DO SO AS WELL.



WARNING: ALWAYS HAVE ADEQUATE VENTILATION. CLEANING FIREARMS IN POORLY VENTILATED AREAS, DISCHARGING FIREARMS, OR HANDLING AMMUNITION AND LOADING COMPONENTS MAY RESULT IN EXPOSURE TO LEAD AND OTHER SUBSTANCES KNOWN TO CAUSE BIRTH DEFECTS, REPRODUCTIVE HARM AND OTHER SERIOUS PHYSICAL INJURY. WASH HANDS THOROUGHLY AFTER EXPOSURE.



WARNING: NEVER RELY ON MECHANICAL FEATURES ALONE. ONLY YOUR SAFE GUN HANDLING WILL ENSURE THE SAFE USE OF YOUR FIREARM. THIS IS YOUR RESPONSIBILITY.



WARNING: WHEN FIRING THE T/C OMEGA, HOLD IT FIRMLY, ALLOWING YOUR BODY WEIGHT TO ABSORB AND BUFFER THE FORCE OF THE RECOIL. AN IMPROPERLY HELD FIREARM CAN CAUSE POSSIBLE INJURY AND/OR BRUISING.

The instant before firing, you must prime the Omega muzzle-loading rifle. With the muzzle pointed in a safe direction, open the action and press a 209 primer into the breech plug primer pocket. Tip the breech back up and lock it closed via the trigger guard - at this point the firearm is ready to fire.

- Grasp rifle firmly with the trigger finger resting along and outside of the trigger guard (Figure 15).
- Raise firearm and pull the stock firmly into the shoulder.
- Draw the hammer back to the full rearward "COCKED" position (Figure 16).
- The gun will now fire when pressure is applied to the trigger.
- Place your finger on the trigger and squeeze until the gun fires.



FIGURE 15

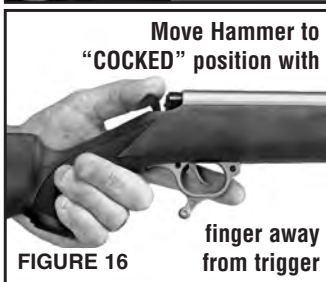

Move Hammer to "COCKED" position with

finger away from trigger

FIGURE 16

FIRING THE T/C OMEGA CONT'D

- To reload, see the Section on “CHARGING.”

! WARNING: IF THE FIREARM IS NO LONGER GOING TO BE USED, UNCHARGE IT BY FIRING IT INTO A SUITABLE BACKSTOP OR PULL THE CHARGE BEFORE RETURNING IT TO YOUR VEHICLE, CAMP OR HOME (SEE SECTION ON “UNLOADING”). AN ACCIDENTAL DISCHARGE CAN CAUSE INJURY AND/OR DEATH TO THE SHOOTER OR BYSTANDERS AND DAMAGE TO PROPERTY.

If you decide not to fire: first, make sure the gun is always pointed in a safe direction - then you must carefully lower the hammer from the “Cocked” position to the “At Rest” position. To do this, hold your thumb securely on the hammer so it cannot drop freely - then pull the trigger back (only long enough to disengage the hammer from the sear) (Figure 17) and allow the hammer to move forward slowly - with your trigger finger now fully away from the trigger - until the hammer resides in the “At Rest” position (Figure 18). Open the breech and remove the 209 primer from the breech plug primer pocket.



! WARNING: IF YOUR FIREARM GIVES ANY INDICATION THAT IT IS NOT PERFORMING PROPERLY OR THE OPERATION OF YOUR FIREARM HAS CHANGED “THE WAY IT FEELS OR SOUNDS,” STOP FIRING. MAKE SURE THE FIREARM IS POINTED IN A SAFE DIRECTION, UNLOAD THE FIREARM AND HAVE IT INSPECTED BY A FACTORY TECHNICIAN. CALL THOMPSON/CENTER CUSTOMER SUPPORT.

UNLOADING AND UNCHARGING



WARNING: ALWAYS KEEP THE MUZZLE POINTED IN A SAFE DIRECTION.



WARNING: NEVER ATTEMPT TO PULL A CHARGE FROM YOUR MUZZLELOADER UNTIL YOU ARE ABSOLUTELY CERTAIN THAT THE FIREARM IS UNPRIMED. WHILE IN THE PROCESS OF PULLING THE CHARGE, DO NOT SMOKE, OR BE NEAR ANYONE ELSE WHO IS SMOKING; THE SPARK FROM A LIGHTED CIGARETTE, CIGAR, OR PIPE CAN IGNITE BLACK POWDER, A BLACK POWDER SUBSTITUTE OR CAPS AND PRIMERS. ANY EXTERNAL HEAT SOURCE CAN IGNITE YOUR CHARGE, CAUSING AN EXPLOSION, WHICH COULD RESULT IN INJURY AND/OR DEATH TO THE SHOOTER OR BYSTANDERS AND DAMAGE TO PROPERTY.

UNLOADING A CHARGE FROM THE OMEGA MUZZLELOADER

Under normal conditions the Omega muzzleloader is unloaded simply by firing it into a suitable and safe backstop. There are, however, some conditions under which the firearm cannot be fired and the charge must be removed manually.

SOME OF THE MOST COMMON CONDITIONS ARE AS FOLLOWS:

- If the projectile is not seated firmly against the powder charge, **stop immediately!** Do not attempt to fire the gun. You must remove the charge and then clean the barrel.
- If the Omega muzzleloader is loaded in a proper manner yet fails to fire after repeated priming and clearing of the ignition channel.
- If you are at a location that is unsuitable for discharging the firearm before transporting it.

To remove a charge from your T/C Omega muzzleloader it will be necessary to take the following steps:

- Open the action and make sure that the gun is unprimed.
- Remove the breech plug.
- Once the breech plug has been removed, point the muzzle up. Gravity should then cause the pellets or the loose powder to drop out. The sabot or bullet can then be poked out of the bore with your ramrod. To push the bullet fully out of the barrel, it will be necessary to add the extended super jag (which came with your rifle) to your ramrod, or, you may use a longer "range rod" if you have access to one.

UNLOADING & UNCHARGING CONT'D

- If your propellant (pellets or loose powder) does not come out as a result of gravity, push the entire charge out from the muzzle end with your ramrod and the installed ramrod extension. If that isn't possible, you should then pour water into the breech area of the barrel to fully saturate (and liquefy) the pellets or powder. After the powder is removed, push the bullet out with your ramrod inserted from the muzzle (with the ramrod extension installed if necessary).

If you can't remove the breech plug at this point:

If you can't remove the breech plug in order to unload the charge, it will be necessary to submerge the breech section of the barrel in a pail or bucket of water.

Disassembly of the Omega will be necessary.

- Check to make sure the gun is unprimed by opening the action and removing the primer from the breech plug.
- Detach the barrel/action assembly from the stock as detailed in the **Disassembly Section** of this manual.
- Once the barrel/action assembly is detached - submerge the barrel breech section of the barrel in a pail of water (hot water if possible). Make certain that at least 8" of the breech section is submerged for at least 1/2 hour.
- Once the powder has been soaked for 1/2 hour and rendered inert, try pulling the projectile from the bore by using your ramrod (or a range rod) with a bullet puller. Screw the bullet puller onto your rod, insert from the muzzle end, and when you make contact with the projectile, turn the rod clockwise, screwing the bullet puller into the projectile. Once screwed into the projectile, pull the projectile out. If you are using a sabot, make sure that both the projectile and the sabot are removed from the bore.
- If, for any reason, you are unable to remove the charge in the manner recommended, soak the barrel again. Squirt oil into the primer pocket of the breech plug and into the barrel's breech area in order to ensure that the powder charge is completely inert, (if you were to use water only - it will just dry out over a period of time), and return the barrel to the Customer Service Department with a letter describing the problem.

FIELD CLEANING



WARNING: ALWAYS KEEP THE MUZZLE POINTED IN A SAFE DIRECTION.



WARNING: WEAR SAFETY GLASSES EVERY TIME YOU ASSEMBLE OR DISASSEMBLE YOUR FIREARM AND ATTEMPT CLEANING OR MAINTENANCE.



NEVER ATTEMPT TO CLEAN A CHARGED OR PRIMED MUZZLELOADING FIREARM. AN ACCIDENTAL DISCHARGE CAN CAUSE INJURY AND/OR DEATH TO THE SHOOTER OR BYSTANDERS AND DAMAGE TO PROPERTY.



WARNING: ALWAYS HAVE ADEQUATE VENTILATION. CLEANING FIREARMS IN POORLY VENTILATED AREAS, DISCHARGING FIREARMS, OR HANDLING AMMUNITION AND LOADING COMPONENTS MAY RESULT IN EXPOSURE TO LEAD AND OTHER SUBSTANCES KNOWN TO CAUSE BIRTH DEFECTS, REPRODUCTIVE HARM AND OTHER SERIOUS PHYSICAL INJURY. WASH HANDS THOROUGHLY AFTER EXPOSURE.

NOTE: Residue from burned black powder and black powder substitutes is very corrosive. The fouling or residue left over after firing your muzzleloading firearm can be destructive to the gun's parts. Leaving your firearm uncleaned with this fouling present can lead to a ruined firearm, as the gun's parts will rust and oxidize quickly.

The build-up of fouling from shot to shot will produce shot to shot increases in pressure that will greatly affect accuracy. The bullet lubricant used, the amount of powder in the charge, and the projectile used (sabot or all-lead conical bullet) will all affect the amount of fouling you will produce with each shot. Eventually, if not cleaned, the muzzleloading firearm will become impossible to load properly. Driven part way down the bore and blocked by fouling, a projectile may "hang up" and refuse to budge further.



WARNING: A PROJECTILE WHICH IS SEATED ONLY PART WAY DOWN THE BARREL SETS UP A HIGHLY DANGEROUS CONDITION WHICH MAY CAUSE A BURST BARREL AND INJURY AND/OR DEATH TO THE SHOOTER OR BYSTANDER AND DAMAGE TO PROPERTY. THE PROJECTILE MUST BE SEATED FIRMLY AGAINST THE POWDER CHARGE. IF THE PROJECTILE IS NOT SEATED AGAINST THE POWDER CHARGE THE FIREARM MUST BE DISASSEMBLED AND THE CHARGE REMOVED (SEE SECTION ON "PULLING A CHARGE"). NEVER FIRE A MUZZLELOADING FIREARM UNLESS THE PROJECTILE IS FIRMLY SEATED ON THE POWDER CHARGE.

FIELD CLEANING CONT'D

The Thompson/Center Omega muzzleloader was supplied with a cleaning jag which is the proper size for cleaning the firearm. Use commercial cleaning patches (round or square) or pieces of cotton clothing to clean the bore.

Use the cleaning jag that was provided with the Omega, and a cleaning patch saturated with a bore cleaner like Thompson/Center's Number 13[®] Bore Cleaner. Run the saturated patch up and down the bore a few times - to remove the fouling (Figures 19 and 20).

T/C's Number 13[®] Bore Cleaner is specifically designed for cleaning fouling from Black Powder or Pyrodex[®].

After removing all the fouling, follow up with a few dry patches to thoroughly dry the bore.

Clean the breech assembly with a soft bristle brush dampened with some bore cleaner. When the breech assembly is dry, lightly oil it. Reassemble and check for proper function of the hammer and trigger mechanism.

Use a pressurized moisture displacing oil to clean and lubricate the firing pin within the breech block - as shown (Figure 21).



Figure 19

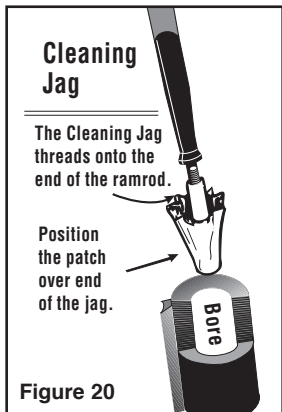

Cleaning Jag

The Cleaning Jag threads onto the end of the ramrod.

Position the patch over end of the jag.

Figure 20



Figure 21

THOROUGH CLEANING



WARNING: ALWAYS KEEP THE MUZZLE POINTED IN A SAFE DIRECTION.



WARNING: WEAR SAFETY GLASSES EVERY TIME YOU ASSEMBLE OR DISASSEMBLE YOUR FIREARM AND ATTEMPT CLEANING OR MAINTENANCE.



WARNING: NEVER ATTEMPT TO CLEAN A CHARGED OR PRIMED MUZZLELOADING FIREARM. AN ACCIDENTAL DISCHARGE CAN CAUSE INJURY AND/OR DEATH TO THE SHOOTER OR BYSTANDERS AND DAMAGE TO PROPERTY.



WARNING: DO NOT ALTER, MODIFY OR REPLACE ANY OF THE PARTS OF YOUR FIREARM UNLESS THIS WORK IS PERFORMED BY A QUALIFIED GUNSMITH USING GENUINE THOMPSON/CENTER PARTS. IF YOU DO OTHERWISE, IMPROPER FUNCTIONING MAY OCCUR AND SERIOUS INJURY MAY RESULT. IT WILL ALSO VOID YOUR WARRANTY.



WARNING: ALWAYS HAVE ADEQUATE VENTILATION. CLEANING FIREARMS IN POORLY VENTILATED AREAS, DISCHARGING FIREARMS, OR HANDLING AMMUNITION AND LOADING COMPONENTS MAY RESULT IN EXPOSURE TO LEAD AND OTHER SUBSTANCES KNOWN TO CAUSE BIRTH DEFECTS, REPRODUCTIVE HARM AND OTHER SERIOUS PHYSICAL INJURY. WASH HANDS THOROUGHLY AFTER EXPOSURE.

Proper cleaning is essential to ensure the proper functioning of your firearm.

Your firearm is a precision instrument. To ensure reliable function it is necessary to follow a routine maintenance procedure. When you are finished shooting for the day or for the season and plan to store the Omega muzzleloader away, you must clean the firearm thoroughly. Follow these instructions for thorough cleaning:

Tip the breech open and be certain that there is no primer in the primer pocket. Then remove the breech plug.

The breech plug is removed from the barrel by turning it counter-clockwise (as viewed from the breech end of the barrel) using the wrench that was supplied with the gun (Figure 22).

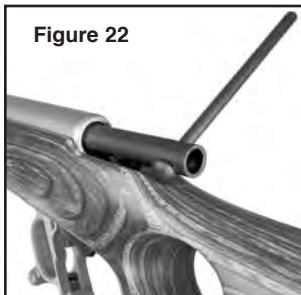

THOROUGH CLEANING CONT'D

Once removed, the breech plug should be scrubbed free of fouling and should then be lubricated with an anti-seize lubricant like T/C's Super Lube, before reinstallation. The threads inside the breech end of the barrel must also be well cleaned with a stiff brush and bore cleaner and then dried and lubricated with anti-seize lube.

Next in the cleaning process; fill a pan with hot soapy water. Submerge the muzzle end of the barrel in the water and push a wet patch down the barrel (from the breech end) on the end of your ramrod that has a jag installed on it (a jag comes with T/C muzzleloaders from the factory). Pump the ramrod and patch up and down in the barrel. This will draw water into the barrel and flush out the fouling.

When the barrel is clean, wipe off any excess water and allow it to dry.

Thoroughly wipe any powder residue from the frame assembly. Dry the parts thoroughly and lubricate them lightly to prevent rust and corrosion.

Use a pressurized moisture displacing oil to clean and lubricate the firing pin within the breech block - as shown (Figure 23).

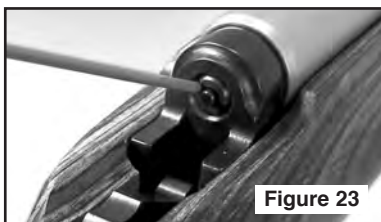

Figure 23



Figure 24

After cleaning your Omega muzzleloader, it is recommended that you lightly lubricate the metal surfaces of the rifle. Do not use heavy grease or oil, as during cold weather, excessive lube may congeal and slow or stop the hammer fall when the trigger is pulled.

With the barrel completely dry, lightly lubricate the bore with a quality gun lubricant or, in keeping with the all-natural method, T/C's Natural Lube 1000 Plus™ Bore Butter. Re-install the breech plug, making sure that you have lubricated all of the threads with an anti-seize lubricant like T/C's Super Lube (Figure 24). The breech plug should be threaded into place by turning it clockwise with the breech plug wrench - until it is seated. Screw the breech plug in carefully. Be certain that the threads mesh properly (not cross-threaded) and ensure that the breech plug is snug.



IMPROPER TYPE OR INSTALLATION OF BREECH PLUGS CAN CAUSE INJURY AND/OR DEATH TO THE SHOOTER OR BYSTANDERS AND DAMAGE TO PROPERTY.

THOROUGH CLEANING CONT'D

Lubricate the threads inside the breech area of the barrel with anti-seize lubricant.

After your Omega muzzleloader breech plug has been reinstalled, check for proper functioning of the barrel and the hammer/trigger mechanism prior to loading and firing.

If the Omega muzzleloader has become very dirty due to extensive firing, the shooter may want to disassemble the rifle further than just removing the breech plug. If this happens, follow the instructions in the **Disassembly Section** that follows.

CAUTION:

Always follow the instructions provided with your gun cleaner and gun lubricant.

CAUTION:

Some cleaners can cause damage to your firearms. You should avoid prolonged solvent immersion and prolonged ultrasonic cleaning of your firearm. Choice of solvent should be restricted to those products specifically developed for firearms maintenance. Damage to a firearm's finish may occur if these cautions are ignored. Ammoniated solvents or other strong alkaline solvents, should not be used on any Thompson/Center firearm. As a rule of thumb, if you would be comfortable applying the solvent of your choice to the finish of your automobile, it will probably be safe for use on your firearm.

DISASSEMBLY OF THE OMEGA MUZZLELOADER



WARNING: ALWAYS KEEP THE MUZZLE POINTED IN A SAFE DIRECTION.



WARNING: MAKE SURE THAT THE MUZZLELOADER IS UNCHARGED AND UNPRIMED. TO ENSURE THAT THE GUN IS UNCHARGED AND UNPRIMED, LOWER THE TRIGGER GUARD AND TIP THE BREECH DOWN. THIS WILL EXPOSE THE PRIMER POCKET IN THE BREECH PLUG. MAKE SURE THERE IS NO PRIMER SEATED IN THE BREECH PLUG PRIMER POCKET. NEXT, HOLDING THE MUZZLE UP TO THE LIGHT, LOOK THROUGH THE IGNITION FIRE CHANNEL FROM THE BREECH END TO MAKE SURE YOU CAN SEE THROUGH IT. IF YOU CANNOT SEE THROUGH IT, EITHER THE GUN IS CHARGED OR THE IGNITION FIRE CHANNEL IS OBSTRUCTED AND IT WILL BE NECESSARY FOR YOU TO REMOVE THE BREECH PLUG AS DETAILED IN THE PREVIOUS SECTION ON THOROUGH CLEANING. IF YOU CAN SEE LIGHT, PROCEED AS FOLLOWS:

DISASSEMBLY OF THE OMEGA CONT'D

The T/C Omega Muzzleloader breaks down into two basic groups of parts as shown below:

- The Barrel and Action Assembly. This assembly is held in the stock by two stock screws; one is located about 1" in front of the trigger guard, and the other is approximately 4" ahead of the first.
- The Stock Assembly – molded composite material or wood.
- **NEVER DISASSEMBLE YOUR FIREARM** beyond the procedures outlined in this manual. Improper disassembly or re-assembly of your firearm may be dangerous and can lead to serious injury or death.

TAKEDOWN OF THE OMEGA MUZZLELOADER

- Make sure that the gun is unprimed and uncharged.
- Remove the ramrod from the thimble(s).
- Lower the swinging breech block to open the action by pivoting the trigger guard forward. This will expose the primer pocket in the breech plug.
- Make sure there is no primer seated. Next, holding the muzzle up to the light, look through the ignition fire channel to make sure you can see through it. If you can not see through it, it is charged or the channel is obstructed and it will be necessary for you to remove the breech plug.
- Close the swinging breech and remove both the front and rear stock/lug assembly screws by turning them counter clockwise. (As viewed from the bottom of the gun)
- The barrel/action assembly may now be lifted out of the stock.
- Open the breech, and insert the breech plug wrench onto the breech plug. Turn counter clockwise to unscrew the breech plug. You may have to exert some initial force in order to "break" the gas seal, which formed when the breech plug was originally "snugged" to the barrel during installation. There will be initial resistance to overcome.

DISASSEMBLY OF THE OMEGA CONT'D

If you need to hold the barrel more firmly than you can with just your hand, a crescent wrench or vise on the barrel lug will supply the needed holding power. This procedure will give you the necessary leverage to “break” the gas seal which was formed when the breech plug was originally “snugged” to the barrel during installation. There will be initial resistance between these parts which must be overcome.

- To reassemble, reverse these steps, making sure that you check for proper functioning of the trigger/hammer mechanism prior to loading and firing. The breech plug of the Omega muzzleloader should be seated in the barrel until it is “snug”. “Snug” is defined as being as tight as you can turn it into the barrel by using the breech plug wrench and turning it clockwise, while holding the barrel in your hand. When you can no longer grip the barrel, and it turns in your hand, the breech plug is “snug”.

The breech plug should be threaded into place by turning it clockwise with the breech plug wrench - until it is seated. Screw the breech plug in carefully. Be certain that the threads mesh properly (are not cross-threaded) and ensure that the breech plug is snug.

Figures 25 and 26 show the extent to which the Omega should be disassembled. If other service is required, contact the Thompson/Center Service Department at 866-730-1614.

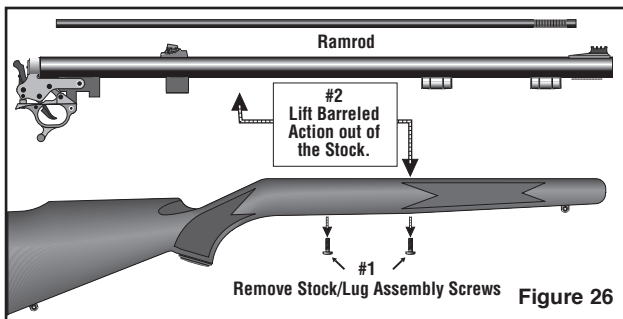
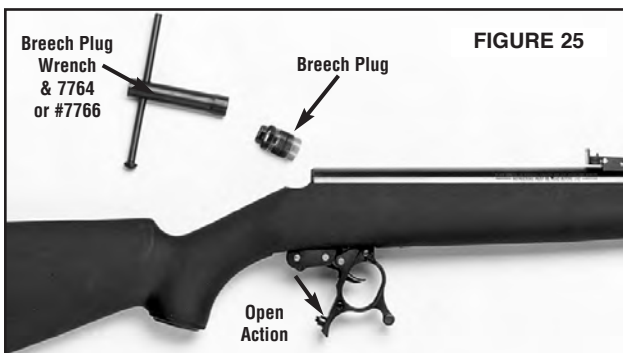

MOUNTING A SCOPE

We recommend that you have a competent gunsmith install your scope and mount.



WARNING: ALWAYS ENSURE THAT THE FIREARM IS UNCHARGED AND UNPRIMED BEFORE INSTALLING A SCOPE OR ANY ACCESSORIES. FAILURE TO DO THIS CAN CAUSE PERSONAL INJURY OR DEATH TO YOU OR OTHERS.



WARNING: DO NOT DRILL ADDITIONAL HOLES IN THE BARREL AS THIS COULD WEAKEN ITS STRUCTURE AND CONTRIBUTE TO A RUPTURE CAUSING INJURY AND/OR DEATH TO THE SHOOTER OR BYSTANDERS AND DAMAGE TO PROPERTY. IT WILL ALSO VOID YOUR WARRANTY.

The barrel is factory drilled and tapped for T/C mounts. Follow the instructions that come with your scope and the mounts for proper installation. Questions should be addressed to the Thompson/Center Service Department at 866-730-1614.



WARNING: FIRING A SCOPED FIREARM WITH YOUR EYE TOO CLOSE TO THE SCOPE EYE PIECE, OR FAILING TO HOLD THE FIREARM SECURELY AGAINST RECOIL, MAY RESULT IN SERIOUS PERSONAL INJURY INCLUDING, BUT NOT LIMITED TO, BLINDNESS.



WARNING: A SCOPE WHICH IS NOT SECURELY MOUNTED MAY BECOME DETACHED UPON RECOIL OF THE FIREARM. IF IT BECOMES DETACHED IT MAY FLY BACK AND STRIKE THE SHOOTER OR A BYSTANDER AND CAUSE INJURY. OBSERVE THE CONDITION OF ALL THE SCOPE MOUNT SCREWS AFTER FIRING. IF THE MOUNTING SCREWS SHOW SIGNS OF LOOSENING DO NOT FIRE THE FIREARM AGAIN; TAKE IT TO A QUALIFIED GUNSMITH FOR ASSISTANCE.

SIGHT ADJUSTMENT



WARNING: ALWAYS POINT THE MUZZLE IN A SAFE DIRECTION.



WARNING: ALWAYS ENSURE THAT THE FIREARM IS UNCHARGED AND UNPRIMED BEFORE ATTEMPTING ANY ADJUSTMENTS. FAILURE TO DO THIS CAN CAUSE PERSONAL INJURY OR DEATH TO YOU OR OTHERS.

Omega muzzleloaders are equipped with either of two rear sights.

• **Rear Sight Type 1 (Figure 28)** - To adjust elevation, moving the elevation “blade” up or down changes the point of impact. To do this, turn the Elevation Adjustment Screw clockwise (as viewed from the receiver end) to lower the point of impact, and counter-clockwise, to raise the point of impact.

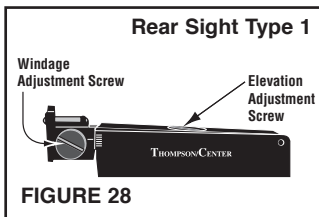

To adjust the windage it is necessary to move the entire rear sight leaf left or right by using the slotted screw head on the right side of the rear sight (as viewed from the receiver end of the sight). Move the rear sight blade in the direction you want your shots to hit--

(Example; Turn the screw clockwise - thereby moving the sight blade to the right, to move your shots to the right and counter-clockwise to move the shots to the left).

• **Rear Sight Type 2 (Figure 29)** - To adjust elevation, move the elevation slide up or down its ramp to change the point of impact. To do this, turn the Elevation Adjustment Lock Screw counter-clockwise (as viewed from the receiver end) to loosen it - then move the slide down the ramp (using the graduation lines as a guide) to lower the point of impact.

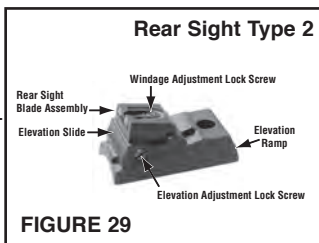

To adjust the windage it is necessary to slide the rear sight blade assembly left or right after loosening the Windage Adjustment Lock Screw. Move the rear sight blade in the direction you want your shots to hit-- (Example; moving the sight blade to the right moves your shots to the right and to the left move the shots to the left).

LIMITED LIFETIME WARRANTY

This warranty is granted by Thompson/Center Arms Company, Inc. This warranty, which shall last for the Lifetime of the original owner of any factory finished firearm, is established by the return of the Thompson/Center Arms authorized warranty card within thirty (30) days of purchase of such firearm. With respect to such firearm, this warranty supersedes any and all other warranties.

Thompson/Center Arms firearms are warranted to be free from defects in material and workmanship. Any such defects of which Thompson/Center Arms receives written notice by the original owner will be remedied by Thompson/Center Arms without charge within a reasonable time after such notification and delivery of the firearm as provided below.

Warranty claims (in writing) and the firearm or part thereof concerned should be delivered, postage prepaid, to the factory at Thompson/Center, 2100 Roosevelt Avenue • Springfield, MA 01104. In addition, a copy of the bill of sale in the owner's name, or, where applicable, a copy of ATF Form 4473 indicating date of purchase must be included. It is important that the owner comply with all applicable federal, state and local laws and regulations in the shipment of firearms to Thompson/Center Arms.

Warranty claims should state the model and, where applicable, the serial number of the firearm concerned and the description of the difficulty experienced. It is recommended that shipments be insured by the owner, since Thompson/Center Arms will accept no responsibility for loss or damage in transit. Transportation and insurance charges for return to the owner will be paid by Thompson/Center Arms if the claim is covered by this warranty.

UNDER NO CIRCUMSTANCES SHALL THOMPSON/CENTER ARMS BE RESPONSIBLE FOR INCIDENTAL OR CONSEQUENTIAL DAMAGES WITH RESPECT TO ECONOMIC LOSS, INJURY, DEATH OR PROPERTY DAMAGE, WHETHER AS A RESULT OF BREACH OF THIS WARRANTY, NEGLIGENCE OR OTHERWISE.

Some States do not allow the exclusion or limitation of incidental or consequential damages, so the above limitation or exclusion may not apply to you.

Thompson/Center Arms will not be responsible for:

- Defects or malfunctions resulting from careless handling, unauthorized adjustments or modifications made or attempted by anyone other than a qualified gunsmith following Thompson/Center Arms authorized procedures, or failure to follow the instructions in the Thompson/Center Arms Safety & Instruction manual.

LIMITED LIFETIME WARRANTY CONT'D

- Use of defective or improper ammunition and/or propellant, corrosion, neglect, abuse, ordinary wear and tear, or unreasonable use.
- Use of replacement parts, including but not limited to barrels and springs, other than Thompson/Center Arms factory or authorized parts.
- Criminal misuse, negligence, or use under the influence of drugs or alcohol.

Services performed by the Thompson/Center Arms Custom Shop and/or Repair Department do not void this warranty. This warranty gives you specific legal rights, and you may also have other rights which vary from State to State.

Note: All liability is excluded in the event that the instructions in the Thompson/Center Arms Safety and Instruction manual are not observed.

CONTACT & SHIPPING FOR SERVICE

Shipping Address: Thompson/Center Arms Company
2100 Roosevelt Avenue
Springfield, MA 01104

Should your Thompson/Center firearm require service, it should be returned to the Thompson/Center factory.

- Call or e-mail the Customer Service Dept. for authorization and shipping instructions.
- Ensure that both the magazine and chamber are unloaded.
- **Do not attempt to ship a firearm via US Postal Service; only federally licensed dealers may ship a firearm by US Postal Service.**
- **DO NOT SHIP ANY AMMUNITION.**
- Enclose a letter which includes your full name and address (no P.O. Boxes, please), daytime telephone number, e-mail address, the serial number of the firearm, and details of the problem experienced (stating the brand and type of ammunition used when the problem occurred) or work desired.
- Record the serial number before shipping, in case you wish to check on the repair status of your firearm.

CONTACT & SHIPPING FOR SERVICE CONT'D

- Please remove all custom parts and accessories, such as stocks, special sights and scopes, or slings from your firearm before returning.
- Place the firearm in its original case or in a similarly secure container and pack it securely.
- The package must **NOT** bear any markings which indicate the identity of the contents.
- It is most important that you comply with federal, state, and local laws and regulations. The following guidelines are meant to help, but you must seek assistance from the appropriate authorities if necessary.
- If your firearm must be replaced, it *may* be necessary to ship the replacement to a dealer rather than directly to you. You *may* be requested to furnish a signed FFL (Federal Firearms License) from your dealer in such an instance.
- Warranty repair work will begin upon receipt and examination of the firearm. In the case of repairs or work not covered by the warranty, a quotation covering the cost of the work plus round trip transportation charges will be sent to you. Repairs or modification will begin upon receipt of payment.

 **WARNING: YOU MAY PURCHASE ACCESSORIES FOR YOUR THOMPSON/CENTER FIREARM. YOU MUST HAVE SOME OF THESE PARTS INSTALLED BY A GUNSMITH QUALIFIED TO PERFORM SERVICE ON THOMPSON/CENTER FIREARMS. NEVER ATTEMPT TO MODIFY YOUR FIREARM OR INSTALL REPLACEMENT PARTS IN YOUR FIREARM. ALWAYS USE A QUALIFIED THOMPSON/CENTER GUNSMITH EVEN IF THE REPAIR SEEMS SIMPLE.**

LOAD COMPONENTS

 **WARNING: NEVER USE LOADING COMPONENTS NOT SPECIFICALLY REFERENCED IN THIS MANUAL. FAILURE TO FOLLOW THIS RULE MAY CAUSE EXCESSIVE PRESSURE WHICH CAN DAMAGE OR EVEN RUPTURE YOUR FIREARM, CAUSING PERSONAL INJURY, DEATH OR PROPERTY DAMAGE.**

- **USE ONLY BLACK POWDER OR AN APPROVED BLACK POWDER SUBSTITUTE SUCH AS PYRODEX® TO LOAD YOUR MUZZLELOADING FIREARM.** Never use even small amounts of smokeless powder, even if it is black in color. The use of any other propellant may cause injury or death to the shooter or bystanders and damage to property.

LOAD COMPONENTS FOR OMEGA CONT'D

- **YOU ARE RESPONSIBLE FOR USING THE CORRECT COMBINATION OF LOAD COMPONENTS IN YOUR OMEGA MUZZLELOADER** as detailed in this manual.

NOTE: Different combinations of bullet weight and powder charge can have a major effect on felt recoil. Heavier bullets and heavier powder charges will result in more recoil.



WARNING: DEATH, SERIOUS INJURY AND DAMAGE CAN RESULT FROM THE USE OF INCORRECT LOAD COMPONENTS.

SUGGESTED LOADS FOR THE T/C OMEGA MUZZLELOADER

The following charts show recommended charges using Black Powder or a Pyrodex[®] equivalent as the propellant for Thompson/Center Omega muzzleloading rifles. Charges are listed by caliber, powder charge and type of projectile.

Note that in each instance a series of charges are listed. More than one charge is shown in each category to clearly illustrate the appropriate powder charge range for that particular caliber, gun model and projectile.



WARNING: MAXIMUM LOADS ARE NOT TO BE EXCEEDED NOR IS A SUBSTITUTION OF POWDER OR GRANULATIONS TO BE ATTEMPTED! ONLY USE LOADS THAT ARE LISTED FOR YOUR PARTICULAR CALIBER, MODEL AND BULLET STYLE. FAILURE TO FOLLOW THESE INSTRUCTIONS MAY RESULT IN INJURY AND/OR DEATH TO THE SHOOTER OR BYSTANDERS AND DAMAGE TO PROPERTY.

The shooter is instructed to start with the lightest charge listed. As you become familiar with the firearm, increase your charges gradually until you reach your best performing load (most accurate). Thompson/Center Arms is not responsible for loading information printed in sources other than this booklet.

NOTE: All loading data contained in this book is the result of testing by Thompson/Center Arms. Testing was done under carefully controlled conditions with the components specified in the text. 28 inch barrels were used to produce the data (unless otherwise specified).

Since Thompson/Center has no control over the components or equipment which may be used with this information, no responsibility is implied or assumed for the results obtained.

SUGGESTED LOADS FOR OMEGA CONT'D



WARNING: THE LOADING DATA FOUND IN THIS MANUAL WAS COMPILED USING BLACK POWDER OR PYRODEX AS A PROPELLANT. WITH ANY OTHER APPROVED BLACK POWDER SUBSTITUTE FOLLOW THE INSTRUCTIONS SUPPLIED BY THE MANUFACTURER AND HEED ALL WARNINGS AS THEY APPLY TO LOADING AND USAGE OF THAT PRODUCT.

Assembly & Loading T/C Mag Express® & Shock Wave® Sabots

T/C Sabots come in several variations for .50 caliber muzzleloading applications; some accept 44 caliber (.429" - .430" diameter) bullets and others accept 45 caliber (.451" - .452" diameter) bullets. In either case, insert the correct diameter projectile into the sabot and press firmly, making sure the bullet is fully seated.

FIGURE 30

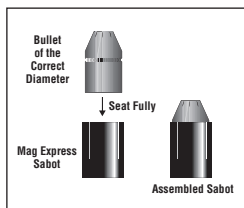

The Assembled Sabot Must Be Seated Firmly On The Powder Charge.



WARNING: WHEN LOADING T/C'S MAG EXPRESS® SABOTS, MAKE SURE THAT YOUR GUN IS UNPRIMED, AND THAT YOUR SABOT HAS BEEN PROPERLY ASSEMBLED. FAILURE TO ASSEMBLE AND LOAD YOUR SABOT CORRECTLY COULD RESULT IN THE BULLET DISENGAGING FROM THE SABOT. THIS COULD RESULT IN AN AIR SPACE BETWEEN THE COMPONENTS. UNDER SUCH A CONDITION, ONE OR MORE OF THE COMPONENTS MAY ACT AS A BARREL OBSTRUCTION AND FIRING COULD RESULT IN INJURY AND/OR DEATH TO THE SHOOTER OR BYSTANDERS AND DAMAGE TO PROPERTY.

To properly assemble your T/C Mag Express® Sabot, insert the projectile into the sabot and press firmly, making sure the bullet is fully seated (Figure 30). Use only bullets of the correct diameter.

MAG EXPRESS & SHOCK WAVE® SABOTS CONT'D



WARNING: USE ONLY PROJECTILES OF THE CORRECT DIAMETER THAT WERE DESIGNED FOR THE SABOTS YOU ARE USING. USING BULLETS OF LESSER DIAMETER MAY CAUSE THE BULLET TO SEPARATE FROM THE SABOT RESULTING IN A BARREL OBSTRUCTION. USING BULLETS OF LARGER DIAMETER COULD RESULT IN DIFFICULT LOADING, OR A CONDITION WHERE THE SABOT IS NOT SEATED ALL THE WAY DOWN ON THE POWDER CHARGE, RESULTING IN A BARREL OBSTRUCTION. EITHER CASE CAN RESULT IN A DAMAGED FIREARM AND POSSIBLE INJURY AND/OR DEATH TO THE SHOOTER OR BYSTANDERS AND DAMAGE TO PROPERTY.



WARNING: THE LOAD DATA PROVIDED HERE IS FOR USE IN RIFLES OF THOMPSON/CENTER MANUFACTURE ONLY. FOR LOAD DATA FOR OTHER BRANDS REFER TO THEIR SPECIFIC LOAD DATA.

For Use With .50 Caliber T/C Omega Muzzleloader Only Using Powder Charge and Bullet Weights Listed. Use #209 Primer for Ignition		.50 Caliber Rifle Using Pyrodex® Pellets & Mag Express® Sabot Loads	
Use With Bullets Weighing (Grains)	Powder Charge 50 cal/50 grain Pyrodex® Pellets	Muzzle Velocity (Feet Per Second)	Muzzle Energy (Foot Pounds)
180 Gr. Bullet	2 Pellets	1937 F.P.S.	1500 Ft. Lbs.
	3 Pellets	2303 F.P.S.	2120 Ft. Lbs.
240 Gr. Bullet	2 Pellets	1889 F.P.S.	1902 Ft. Lbs.
	3 Pellets	2249 F.P.S.	2696 Ft. Lbs.
250 Gr. Bullet	2 Pellets	1863 F.P.S.	1927 Ft. Lbs.
	3 Pellets	2197 F.P.S.	2680 Ft. Lbs.
300 Gr. Bullet	2 Pellets	1729 F.P.S.	1992 Ft. Lbs.
	3 Pellets	2036 F.P.S.	2762 Ft. Lbs.
325 Gr. Bullet	2 Pellets	1624 F.P.S.	1903 Ft. Lbs.
	3 Pellets	1938 F.P.S.	2711 Ft. Lbs.
400 Gr. Bullet	2 Pellets	1512 F.P.S.	2031 Ft. Lbs.
	3 Pellets	1806 F.P.S.	2897 Ft. Lbs.
Load Shown in Red is Maximum			

For Use With .50 Caliber T/C Omega Muzzleloader Only Using Bullet & Powder Listed Use #209 Primer for Ignition		.50 Caliber Rifle Using Black Powder & Mag Express® Sabot Loads	
For Use With Bullets Weighing (Grains)	Black Powder Charge (Grains)	Muzzle Velocity (Feet Per Second)	Muzzle Energy (Foot Pounds)
180 Grain Bullet Like The Thompson/Center XTP™	80 grs. FFG	1609 F.P.S.	1035 Ft. Lbs.
	90 grs. FFG	1685 F.P.S.	1135 Ft. Lbs.
	100 grs. FFG	1737 F.P.S.	1206 Ft. Lbs.
	110 grs. FFG	1766 F.P.S.	1247 Ft. Lbs.
	120 grs. FFG	1852 F.P.S.	1371 Ft. Lbs.
	130 grs. FFG	1907 F.P.S.	1454 Ft. Lbs.
	140 grs. FFG	2004 F.P.S.	1606 Ft. Lbs.
	150 grs. FFG	2043 F.P.S.	1669 Ft. Lbs.
240 Grain Bullet Like The Thompson/Center XTP™	80 grs. FFG	1511 F.P.S.	1217 Ft. Lbs.
	90 grs. FFG	1629 F.P.S.	1414 Ft. Lbs.
	100 grs. FFG	1672 F.P.S.	1490 Ft. Lbs.
	110 grs. FFG	1710 F.P.S.	1559 Ft. Lbs.
	120 grs. FFG	1761 F.P.S.	1653 Ft. Lbs.
	130 grs. FFG	1794 F.P.S.	1716 Ft. Lbs.
	140 grs. FFG	1846 F.P.S.	1816 Ft. Lbs.
	150 grs. FFG	1879 F.P.S.	1882 Ft. Lbs.
250 Grain Bullet Like The Thompson/Center PTX™	80 grs. FFG	1472 F.P.S.	1203 Ft. Lbs.
	90 grs. FFG	1601 F.P.S.	1423 Ft. Lbs.
	100 grs. FFG	1642 F.P.S.	1497 Ft. Lbs.
	110 grs. FFG	1696 F.P.S.	1597 Ft. Lbs.
	120 grs. FFG	1724 F.P.S.	1650 Ft. Lbs.
	130 grs. FFG	1775 F.P.S.	1749 Ft. Lbs.
	140 grs. FFG	1828 F.P.S.	1855 Ft. Lbs.
	150 grs. FFG	1853 F.P.S.	1907 Ft. Lbs.
300 Grain Bullet Like The Thompson/Center XTP™	80 grs. FFG	1452 F.P.S.	1405 Ft. Lbs.
	90 grs. FFG	1535 F.P.S.	1570 Ft. Lbs.
	100 grs. FFG	1601 F.P.S.	1708 Ft. Lbs.
	110 grs. FFG	1646 F.P.S.	1805 Ft. Lbs.
	120 grs. FFG	1667 F.P.S.	1852 Ft. Lbs.
	130 grs. FFG	1693 F.P.S.	1910 Ft. Lbs.
	140 grs. FFG	1714 F.P.S.	1957 Ft. Lbs.
	150 grs. FFG	1758 F.P.S.	2015 Ft. Lbs.

Load Shown in Red is Maximum - Heavier Bullets continued next page...

T/C Mag Express® Sabot Loads CONT'D

... continued from previous page.

For Use With .50 Caliber T/C Omega Muzzleloader Only Using Powder Charge and Bullet Weights Listed. Use #209 Primer for Ignition		.50 Caliber Rifle Using Black Powder & Mag Express® Sabot Loads	
For Use With Bullets Weighing (Grains)	Black Powder Charge (Grains)	Muzzle Velocity (Feet Per Second)	Muzzle Energy (Foot Pounds)
325 Grain Bullet	100 grs. FFG	1451 F.P.S.	1520 Ft. Lbs.
	120 grs. FFG	1555 F.P.S.	1745 Ft. Lbs.
	150 grs. FFG	1710 F.P.S.	2110 Ft. Lbs.
400 Grain Bullet	100 grs. FFG	1390 F.P.S.	1679 Ft. Lbs.
	120 grs. FFG	1469 F.P.S.	1917 Ft. Lbs.
	150 grs. FFG	1587 F.P.S.	2238 Ft. Lbs.
Load Shown in Red is Maximum			

T/C Shock Wave® Sabot Loads

For Use With .50 Caliber T/C Omega Muzzleloader Only Using Powder Charge and Bullet Weights Listed. Use #209 Primer for Ignition		.50 Caliber Rifle Using 50 Gr. Equivalent Pyrodex® Pellets & Shock Wave® Bullets with T/C Super Glide™ Sabots	
Use With Bullets Weighing (Grains)	Powder Charge 50 cal/50 grain Pyrodex® Pellets	Muzzle Velocity (Feet Per Second)	Muzzle Energy (Foot Pounds)
250 Gr. Bullet Shock Wave® in the T/C Super Glide™ Sabot	2 Pellets	1863 F.P.S.	1927 Ft. Lbs.
	3 Pellets	2197 F.P.S.	2680 Ft. Lbs.
300 Gr. Bullet T/C Shock Wave® in the T/C Super Glide™ Sabot	2 Pellets	1729 F.P.S.	1992 Ft. Lbs.
	3 Pellets	2036 F.P.S.	2762 Ft. Lbs.
Load Shown in Red is Maximum			

For Use With .50 Caliber T/C Omega Muzzleloader Only Using Powder Charge and Bullet Weights Listed. Use #209 Primer for Ignition		.50 Caliber Rifle Using Black Powder & Shock Wave® Bullets with T/C Super Glide™ Sabots	
Use With Bullets Weighing (Grains)	Black Powder Charge (Grains)	Muzzle Velocity (Feet Per Second)	Muzzle Energy (Foot Pounds)
250 Gr. Bullet Shock Wave® in the Super Glide™ Sabot	80 grs. FFG	1472 F.P.S.	1203 Ft. Lbs.
	90 grs. FFG	1601 F.P.S.	1423 Ft. Lbs.
	100 grs. FFG	1642 F.P.S.	1497 Ft. Lbs.
	110 grs. FFG	1696 F.P.S.	1597 Ft. Lbs.
	120 grs. FFG	1724 F.P.S.	1650 Ft. Lbs.
	130 grs. FFG	1775 F.P.S.	1749 Ft. Lbs.
	140 grs. FFG	1828 F.P.S.	1855 Ft. Lbs.
	150 grs. FFG	1853 F.P.S.	1907 Ft. Lbs.
300 Gr. Bullet Shock Wave® in the Super Glide™ Sabot	80 grs. FFG	1452 F.P.S.	1405 Ft. Lbs.
	90 grs. FFG	1535 F.P.S.	1570 Ft. Lbs.
	100 grs. FFG	1601 F.P.S.	1708 Ft. Lbs.
	110 grs. FFG	1646 F.P.S.	1805 Ft. Lbs.
	120 grs. FFG	1667 F.P.S.	1852 Ft. Lbs.
	130 grs. FFG	1693 F.P.S.	1910 Ft. Lbs.
	140 grs. FFG	1714 F.P.S.	1957 Ft. Lbs.
	150 grs. FFG	1758 F.P.S.	2015 Ft. Lbs.
Load Shown in Red is Maximum			

Loading T/C Maxi-Ball™ & Maxi-Hunter® Conical Lead Bullets

For Use Only With .50 Caliber T/C Omega Muzzleloader Only Bullets Lubricated with <i>Natural Lube</i> <i>1000 Plus™ Bore Butter™</i> Use a #209 Primer for Ignition		.50 Caliber Rifle Using Pyrodex® Pellets & Maxi-Ball™ or Maxi-Hunters®	
Use With Bullets Weighing (Grains)	Powder Charge 50 cal/50 grain Pyrodex® Pellets	Muzzle Velocity (Feet Per Second)	Muzzle Energy (Foot Pounds)
275 Gr. Maxi-Hunter® & 320 Gr. Maxi-Ball™	2 Pellets	1718 F.P.S.	2098 Ft. Lbs.
	3 Pellets	2026 F.P.S.	2917 Ft. Lbs.
350 Gr. Maxi-Hunter® & 370 Gr. Maxi-Ball™	2 Pellets	1656 F.P.S.	2253 Ft. Lbs.
	3 Pellets	1891 F.P.S.	2939 Ft. Lbs.
Load Shown in Red is Maximum			

For Use Only With .50 Caliber T/C Omega Muzzleloader Only Bullets Lubricated with <i>Natural Lube</i> <i>1000 Plus™ Bore Butter™</i> Use a #209 Primer for Ignition		.50 Caliber Rifle Using Black Powder & Maxi-Ball™ or Maxi-Hunter® Loads	
Use With Bullets Weighing (Grains)	Black Powder Charge (Grains)	Muzzle Velocity (Feet Per Second)	Muzzle Energy (Foot Pounds)
275 Grain Maxi-Hunter® & 320 Grain Maxi-Ball™ Lead Bullet	80 grs. FFG	1408 F.P.S.	1409 Ft. Lbs.
	90 grs. FFG	1462 F.P.S.	1519 Ft. Lbs.
	100 grs. FFG	1511 F.P.S.	1623 Ft. Lbs.
	110 grs. FFG	1588 F.P.S.	1792 Ft. Lbs.
	120 grs. FFG	1632 F.P.S.	1893 Ft. Lbs.
	130 grs. FFG	1675 F.P.S.	1994 Ft. Lbs.
	150 grs. FFG	1742 F.P.S.	2157 Ft. Lbs.
350 Grain Maxi-Hunter® & 370 Grain Maxi-Ball™ Lead Bullet	80 grs. FFG	1344 F.P.S.	1484 Ft. Lbs.
	90 grs. FFG	1426 F.P.S.	1671 Ft. Lbs.
	100 grs. FFG	1478 F.P.S.	1795 Ft. Lbs.
	110 grs. FFG	1535 F.P.S.	1936 Ft. Lbs.
	120 grs. FFG	1556 F.P.S.	1990 Ft. Lbs.
	130 grs. FFG	1592 F.P.S.	2083 Ft. Lbs.
	150 grs. FFG	1661 F.P.S.	2267 Ft. Lbs.
Load Shown in Red is Maximum			

FOR YOUR RECORDS

Important Note: For fire, theft and insurance purposes, retain this record with your important papers in a safe place.

My Thompson/Center: _____

Was Purchased From: _____

On (date): _____ 20_____

Serial Number: _____ **Caliber:** _____

Accessories: _____

Owner Registration Card Mailed on: _____

Notes: _____

This area is provided for your convenience. We suggest that you make a list of important information that pertains to your specific firearm (best performing load, etc.). Keep this booklet with your firearm and review your notes before each hunting season or whenever the firearm has not been used for extended periods of time.

T/C Mailing Address:

(for questions & comments)

Thompson/Center Arms Company, Inc.

2100 Roosevelt Avenue • Springfield, MA 01104

T/C Shipping Address:

(for repairs or warranty work)

Thompson/Center Arms Company, Inc.

ATTN: Repair Department

2100 Roosevelt Avenue • Springfield, MA 01104

Web Address:

www.tcarms.com

Customer Service Phone:

Toll Free (866) 730-1614